

**Patient leaflet in accordance with the Pharmacists' Regulations (Preparations) -
1986**

This medicine is dispensed with a doctor's prescription only

Wegovy[®] 0.25 mg

Wegovy[®] 0.5 mg

Wegovy[®] 1 mg

Wegovy[®] 1.7 mg

Wegovy[®] 2.4 mg

Solution for injection in pre-filled pen

Active ingredient

Wegovy 0.25 mg
semaglutide 0.68 mg/ml

Wegovy 0.5 mg
semaglutide 1.34 mg/ml

Wegovy 1 mg
semaglutide 1.34 mg/ml

Wegovy 1.7 mg
semaglutide 2.27 mg/ml

Wegovy 2.4 mg
semaglutide 3.2 mg/ml

Inactive ingredients and allergens in this medicine: see section 2 'Important information about some of this medicine's ingredients', and section 6 'Additional information'.

Read the entire leaflet carefully before you start using this medicine. This leaflet contains concise information about this medicine. If you have any further questions, consult your doctor or pharmacist.

This medicine has been prescribed for you. Do not pass it on to others. It may harm them, even if it seems to you that their medical condition is similar to yours.

1. What is this medicine intended for?

Wegovy is indicated as an adjunct to a reduced-calorie diet and increased physical activity for weight management, including weight loss and weight maintenance, in adults with an initial Body Mass Index (BMI) of

- $\geq 30 \text{ kg/m}^2$ (obesity), or
- $\text{BMI} \geq 27 \text{ kg/m}^2$ to $< 30 \text{ kg/m}^2$ (overweight) in the presence of at least one weight-related comorbidity, e.g. impaired blood sugar control (dysglycaemia; prediabetes or type 2 diabetes), hypertension, dyslipidaemia (impaired blood lipid control), obstructive sleep apnoea or cardiovascular disease (disease of the heart and blood vessels)

BMI (Body Mass Index) is a measure of weight in relation to height.

Wegovy is used together with reduced-calorie diet and increased physical activity for weight management in adolescents ages 12 years and above, who have

- obesity and
- body weight > 60 kg.

As an adolescent patient, you should only continue using Wegovy if you have lost at least 5% of your BMI after 12 weeks on the 2.4 mg dose or maximum tolerated dose (see section 3). Consult your doctor before you continue the treatment.

Therapeutic group: Medicines used in diabetes, glucagon-like peptide-1 (GLP-1) analogues

Wegovy is a medicine for weight loss and weight maintenance that contains the active substance semaglutide. It is similar to a natural hormone called glucagon-like peptide-1 (GLP-1) that is released from the intestine after a meal. It works by acting on target proteins (receptors) in the brain that control your appetite, causing you to feel fuller and less hungry and experience less craving for food. This will help you eat less food and reduce your body weight.

2. Before using this medicine

Do not use this medicine if:

- | |
|--|
| <ul style="list-style-type: none">• You are sensitive (allergic) to the active ingredient or to any of the other ingredients in this medicine (see section 6). |
|--|

Special warnings about using this medicine

Before treatment with Wegovy, tell your doctor if:

Talk to your doctor, pharmacist or nurse before using Wegovy. The use of Wegovy is not recommended if you:

- use other products for weight loss
- have type 1 diabetes
- have severely reduced kidney function
- have severely reduced liver function
- have severe heart failure
- have diabetic eye disease (retinopathy).

There is little experience with Wegovy in patients:

- of 75 years and older
- with liver problems
- with severe stomach or gut problem which results in delayed stomach emptying (called gastroparesis), or if you have an inflammatory bowel disease.

Please consult your doctor if one of the above applies to you.

- **Dehydration**

During treatment with Wegovy, you may suffer from nausea, vomiting or diarrhoea. These side effects can cause dehydration (loss of fluids). It is important that you drink enough fluids to prevent dehydration. This is especially important if you have kidney problems. Talk to your doctor if you have any questions or concerns.

- **Inflammation of the pancreas**
If you have severe and on-going pain in the stomach area (see section 4) – see a doctor straight away, as this could be a sign of inflamed pancreas (acute pancreatitis).
- **People with type 2 diabetes**
Wegovy cannot be used as a substitute for insulin. Do not use Wegovy in combination with other medicines that contain GLP-1 receptor agonists (such as liraglutide, dulaglutide, exenatide or lixisenatide).
- **Low blood sugar level (hypoglycaemia)**
Taking a sulfonylurea or an insulin with Wegovy might increase the risk of getting low blood sugar levels (hypoglycaemia). Please see section 4 for warning signs of low blood sugar levels. Your doctor may ask you to test your blood sugar levels. This will help your doctor decide if the dose of the sulfonylurea or insulin needs to be changed to reduce the risk of low blood sugar.
- **Diabetic eye disease (retinopathy)**
If you have diabetic eye disease and are using insulin, this medicine may lead to a worsening of your vision, and this may require treatment. Fast improvements in blood sugar control may lead to a temporary worsening of diabetic eye disease. If you have diabetic eye disease and experience eye problems while taking this medicine, talk to your doctor.

Children and adolescents

The safety and efficacy of Wegovy in children below 12 years of age have not been studied and is not recommended for use in this population.

Interactions with other medicines

If you are taking or have recently taken other medicines, including nonprescription medicines and dietary supplements, tell your doctor or pharmacist.

In particular, tell your doctor or pharmacist if you are using medicines containing the following:

- Warfarin or other similar medicines taken by mouth to reduce blood clotting (oral anticoagulants). When you start treatment with e.g. warfarin or similar medicines, frequent blood testing to determine the ability of your blood to clot may be required.

Pregnancy and breastfeeding

Pregnancy

This medicine should not be used during pregnancy, as it is not known if it may affect your unborn child. Therefore, it is recommended to use contraception while using this medicine. If you wish to become pregnant, you should stop using this medicine at least two months in advance.

If you become or are pregnant, think you may be pregnant or are planning to have a baby when using this medicine, talk to your doctor straight away, as your treatment will need to be stopped.

Breastfeeding

Do not use this medicine if you are breastfeeding, as it is unknown if it passes into breast milk.

Driving and using machines

Wegovy is unlikely to affect (or has a negligible effect) your ability to drive and use machines. Some patients may feel dizzy when taking Wegovy mainly during the first 4 months of treatment (see section 4). If you feel dizzy be extra careful while driving or using machines. If you need any further information, talk to your doctor, pharmacist or nurse.

People with type 2 diabetes

If you use this medicine in combination with a sulfonylurea or insulin, low blood sugar (hypoglycaemia) may occur, which may reduce your ability to concentrate. Avoid driving or using machines if you get any signs of low blood sugar. See section 2 'Special warnings about using this medicine' for information on increased risk of low blood sugar level and section 4 for the warning signs of low blood sugar. Talk to your doctor for further information.

Important information about some of this medicine's ingredients

This medicine contains less than 1 mmol sodium (23 mg) per dose, that is to say essentially 'sodium-free'.

3. How to use this medicine?

Always use this medicine according to your doctor's instructions. Check with your doctor or pharmacist if you are not sure about your dose or about how to take this medicine. Only your doctor will determine your dose and how you should take this medicine. The recommended dosage is usually:

Adults

The recommended dose is 2.4 mg once weekly.

Your treatment will start at a low dose, which will be gradually increased over 16 weeks of treatment.

- When you first start using Wegovy, the starting dose is 0.25 mg once weekly.
- Your doctor will instruct you to gradually increase your dose every 4 weeks until you reach the recommended dose of 2.4 mg once weekly.
- Once you reach the recommended dose of 2.4 mg, do not increase this dose further.
- In case you are feeling very bothered by nausea or by vomiting talk with your doctor about delaying dose escalation or lowering to the previous dose until symptoms have improved.

Usually, you will be told to follow the table below.

Treatment week	Weekly dose
Week 1–4	0.25 mg
Week 5–8	0.5 mg
Week 9–12	1 mg
Week 13–16	1.7 mg
From week 17	2.4 mg

Your doctor will assess your treatment on a regular basis.

Adolescents (above 12 years of age)

For adolescents, the same dosage escalation schedule as for adults should be applied (see table above for adults). The dose should be increased until 2.4 mg

(maintenance dose) or maximum tolerated dose has been reached. Weekly doses higher than 2.4 mg are not recommended.

People with type 2 diabetes

Tell your doctor if you have type 2 diabetes. Your doctor may adjust the dose of your diabetes medicines to prevent you from getting low blood sugar.

Do not exceed the recommended dose.

Mode of administration

Wegovy is given as an injection under the skin (subcutaneous injection). Do not inject it into a vein or muscle.

- The best places to give the injection are the front of your upper arm, upper legs or stomach.
- Before you use the pen for the first time, your doctor, pharmacist or nurse will show you how to use it.

Detailed instructions on how to use the pen are on the other side of this leaflet.

When to use Wegovy

- You should use this medicine once a week and if possible, on the same day each week.
- You can give yourself the injection at any time of the day – regardless of meals.

If necessary, you can change the day of your weekly injection of this medicine as long as it has been at least 3 days since your last injection. After selecting a new dosing day, continue with once a week dosing.

If you have accidentally injected a higher dose

Talk to your doctor straight away. You may get side effects such as nausea, vomiting or have diarrhoea, which may cause dehydration (loss of fluids). If you have injected an overdose, or if a child has accidentally swallowed some medicine, immediately see a doctor or go to a hospital emergency room and bring the medicine package with you.

If you forget to inject the medicine

If you forget to inject a dose at the scheduled time and:

- it is 5 days or less since you should have used Wegovy, use it as soon as you remember. Then inject your next dose as usual on your scheduled day.
- it is more than 5 days since you should have used Wegovy, skip the missed dose. Then inject your next dose as usual on your next scheduled day.

Do not inject a double dose to make up for a forgotten dose.

Adhere to the treatment as recommended by your doctor.

If you stop injecting the medicine

Do not stop using this medicine without talking to your doctor.

Do not take medicines in the dark! Check the label and dose every time you take a medicine. Wear glasses if you need them.

If you have any further questions about using this medicine, consult your doctor or pharmacist.

4. Side effects

As with any medicine, using Wegovy may cause side effects in some users. Do not be alarmed by this list of side effects; you may not experience any of them.

Serious side effects

Common (may affect up to 1 in 10 users)

- Complications of diabetic eye disease (diabetic retinopathy). If you have diabetes you should inform your doctor if you experience eye problems, such as changes in vision, during treatment with this medicine.

Uncommon (may affect up to 1 in 100 users)

- Inflamed pancreas (acute pancreatitis). Signs of inflamed pancreas may include severe and long-lasting pain in your stomach, the pain may move to your back. You should see your doctor immediately if you experience such symptoms.

Rare (may affect up to 1 in 1,000 users)

- Severe allergic reactions (anaphylactic reactions, angioedema). You should seek immediate medical help and inform your doctor straight away if you get symptoms such as breathing difficulty, swelling, light-headedness, fast heartbeat, sweating and loss of consciousness or rapid swelling under the skin in areas such as the face, throat, arms and legs, which can be life threatening if throat swelling blocks the airway.

Not known (frequency cannot be estimated from the available data)

- Bowel obstruction. A severe form of constipation with additional symptoms such as stomach ache, bloating, vomiting etc.

Other side effects

Very common side effects (may affect more than 1 in 10 users)

- headache
- nausea
- vomiting
- diarrhoea
- constipation
- stomach pain
- feeling weak or tired
- these are mainly seen during dose escalation and usually go away over time.

Common side effects (may affect up to 1 in 10 users)

- feeling dizzy
- upset stomach or indigestion
- burping
- gas (flatulence)
- bloating of the stomach
- inflamed stomach ('gastritis') – the signs include stomach-ache, nausea or vomiting
- reflux or heartburn – also called 'gastro-oesophageal reflux disease'
- gallstones
- hair loss
- injection site reactions
- change in the way food or drink tastes

- low blood sugar (hypoglycaemia) in patients with type 2 diabetes.

The warning signs of low blood sugar may come on suddenly. They can include: cold sweat, cool pale skin, headache, fast heartbeat, nausea or feeling very hungry, changes in vision, feeling sleepy or weak, feeling nervous, anxious or confused, difficulty concentrating or shaking.

Your doctor will tell you how to treat low blood sugar and what to do if you notice these warning signs.

Low blood sugar is more likely to happen if you also take a sulfonylurea or insulin. Your doctor may reduce your dose of these medicines before you start using this medicine.

Uncommon side effects (may affect up to 1 in 100 users)

- low blood pressure
- feeling dizzy or lightheaded on standing or sitting up because of a drop in blood pressure
- fast heartbeat
- increase in pancreatic enzymes (such as lipase and amylase) shown in blood tests
- a delay in the emptying of the stomach.

If you experience any side effect, if any side effect gets worse, or if you experience a side effect not mentioned in this leaflet, consult your doctor.

Reporting side effects

You can report side effects to the Ministry of Health by following the 'Reporting Side Effects of Drug Treatment' link on the Ministry of Health home page (www.health.gov.il), which opens an online form for reporting side effects, or you can also use this link: <https://sideeffects.health.gov.il>

5. How to store the medicine?

- Prevent poisoning! To prevent poisoning, keep this and all other medicines in a closed place, out of the reach and sight of children and/or infants. Do not induce vomiting unless explicitly instructed to do so by your doctor.
- Do not use the medicine after the expiry date (exp. date) which is stated on the pen label and the package. The expiry date refers to the last day of that month.

Storage conditions

Before opening

Store in a refrigerator (2°C – 8°C). Do not freeze. Keep away from the cooling element.

After opening

- You can keep the pen for 6 weeks when stored at a temperature below 30°C or in a refrigerator (2°C – 8°C) away from the cooling element. Do not freeze Wegovy and do not use it if it has been frozen.
- When you are not using the pen, keep the pen cap on in order to protect from light.

Do not use this medicine if you notice that the solution is not clear and colourless.

Do not throw away any medicines via wastewater or household waste. Ask your pharmacist how to throw away medicines you no longer use. These measures will help protect the environment.

6. Additional information

In addition to the active ingredient, this medicine also contains:

Propylene glycol, phenol, disodium phosphate dihydrate, hydrochloric acid/sodium hydroxide (for pH adjustment) and water for injections.

What the medicine looks like and contents of the pack:

Wegovy 0.25 mg: Each pre-filled pen contains 1 mg semaglutide in 1.5 ml

Wegovy 0.5 mg: Each pre-filled pen contains 2 mg semaglutide in 1.5 ml

Wegovy 1 mg: Each pre-filled pen contains 4 mg semaglutide in 3 ml

Wegovy 1.7 mg: Each pre-filled pen contains 6.8 mg semaglutide in 3 ml

Wegovy 2.4 mg: Each pre-filled pen contains 9.6 mg semaglutide in 3 ml

Wegovy is a clear and colourless solution for injection in a pre-filled pen.

Each pre-filled pen contains 4 doses.

Wegovy 0.25, 0.5, 1, 1.7 and 2.4 mg solution for injection in a pre-filled FlexTouch pen is available in the following pack sizes:

1 pre-filled pen and 4 disposable NovoFine Plus needles.

Registration holder's name and address:

Novo Nordisk Ltd.

1 Atir Yeda St.

Kfar Saba 4464301

Manufacturer's name and address:

Novo Nordisk A/S

Novo Allé, DK-2880 Bagsværd,

Denmark

Revised in Apr-2024.

Registration number of the medicine in the National Drug Registry of the Ministry of Health:

Wegovy 0.25 mg: 172-70-37485

Wegovy 0.5 mg: 172-71-37486

Wegovy 1 mg: 172-72-37487

Wegovy 1.7 mg: 172-73-37488

Wegovy 2.4 mg: 172-74-37489

Instructions on how to use Wegovy

Before you begin using your once-weekly Wegovy FlexTouch pen, **always read these instructions carefully** and talk to your doctor, nurse or pharmacist about how to inject Wegovy correctly.

Wegovy pen is a dial-a-dose pen that **contains four of your prescribed doses of Wegovy, corresponding to four times of once-weekly use.**

Please use the table inside the lid of the carton to keep track of how many injections you have used and how many doses remain in your pen.

Wegovy comes in five different pens, each containing one of the following prescribed doses of semaglutide:

0.25 mg 0.5 mg 1 mg 1.7 mg 2.4 mg

Always start by checking your pen label to make sure that it contains your prescribed dose of Wegovy.

Your pen is designed to be used with 30G, 31G, and 32G disposable needles up to a length of 8 mm.

The pack contains:

- Wegovy pen
- 4 NovoFine Plus needles
- Patient leaflet

Wegovy FlexTouch pen (example)

Please note: Your pen may differ in size and your pen label may differ in colour from the example shown in the pictures. These instructions apply to all Wegovy FlexTouch pens.

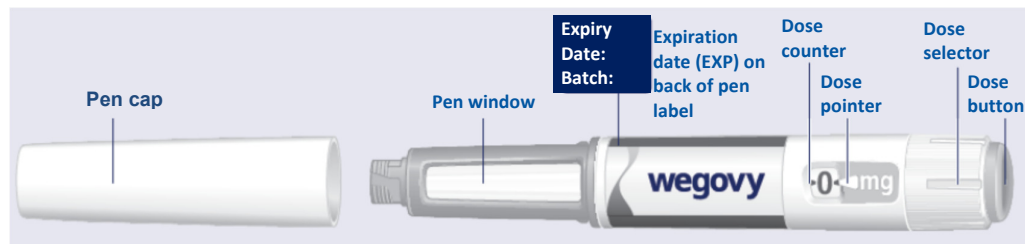

NovoFine Plus needle (example)

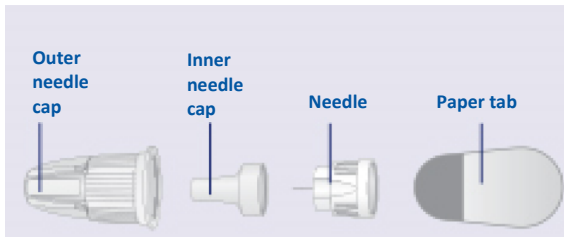

1 Prepare your pen with a new needle

Check the name and dose of your pen to make sure it contains your prescribed dose of Wegovy.

Pull off the pen cap.

(See figure A).

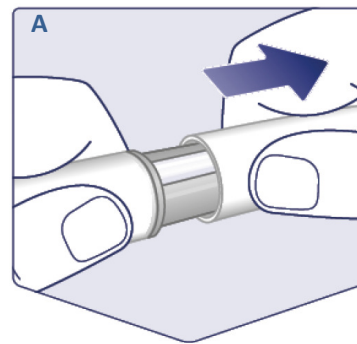

Check that the solution in your pen is clear and colourless.

Look through the pen window. If Wegovy looks cloudy or coloured, do not use the pen.

(See figure B).

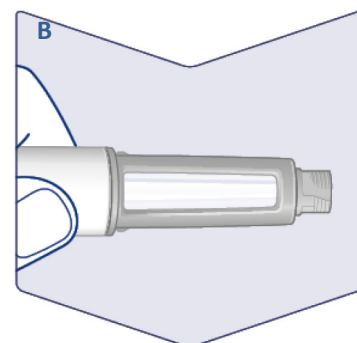

Always use a new needle for each injection.

Take a needle when you are ready to take your injection. Check the paper tab and the outer needle cap for damages that could affect sterility. If any damage is seen, use a new needle.

Tear off the paper tab.

(See figure C).

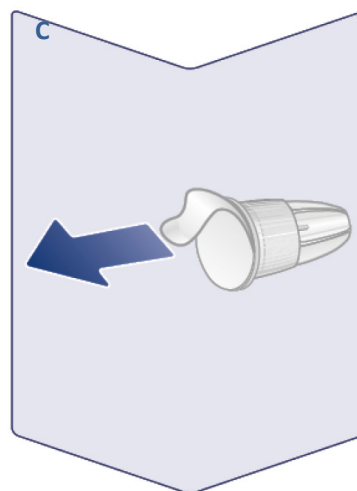

Push the needle straight onto the pen. Turn until it is on tight.
(See figure D).

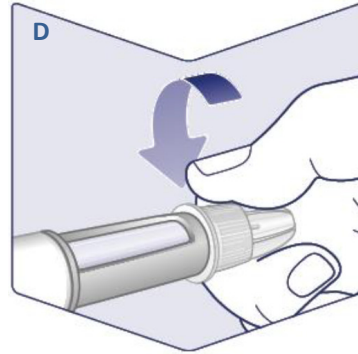

The needle is covered by two caps. You must remove both caps. If you forget to remove both caps you will not inject any Wegovy.

Pull off the outer needle cap and keep it for later. You will need it to safely remove the needle from the pen after the injection.

Pull off the inner needle cap and dispose of it. A drop of Wegovy may appear at the needle tip. You must still check the Wegovy flow if you use a new pen for the first time. See '**Check the flow with each new pen**'.

Never use a bent or damaged needle. For more information about needle handling, see '**About your needles**' below these instructions.

(See figure E).

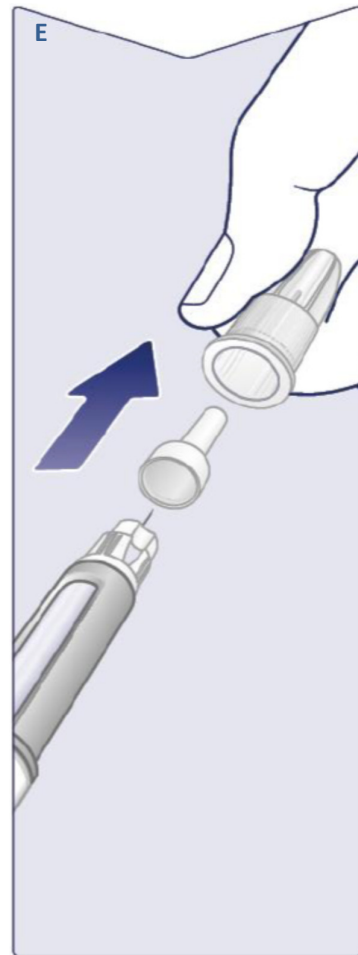

Check the flow with each new pen

If your Wegovy pen is already in use, go to '**2 Set your dose**'.

Only check the Wegovy flow before your **first injection with each new pen**.

Turn the dose selector until you see the flow check symbol (■ ■ ▲).

(See figure F).

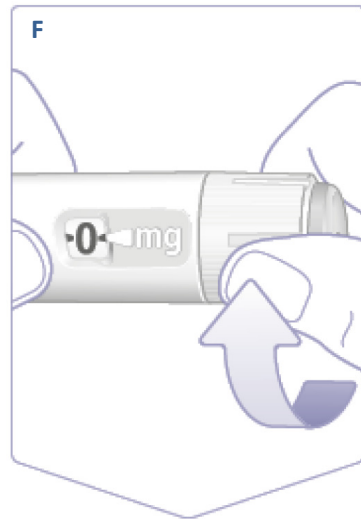

Make sure the flow check symbol lines up with the dose pointer.

(See figure G).



Check the flow

Hold the pen with the needle pointing up.

Press and hold in the dose button until the dose counter returns to 0. The 0 must line up with the dose pointer.

A drop of Wegovy should appear at the needle tip. This drop indicates that your pen is ready for use.

If a drop does not appear, check the flow again.
This should only be done twice.

If there is still no drop, **change the needle and check the flow once more.**

Do not use the pen if a drop of Wegovy still does not appear.

(See figure H).



2 Set your dose

Turn the dose selector until the **dose counter stops**, and it **shows your prescribed dose**.

(See figure I).

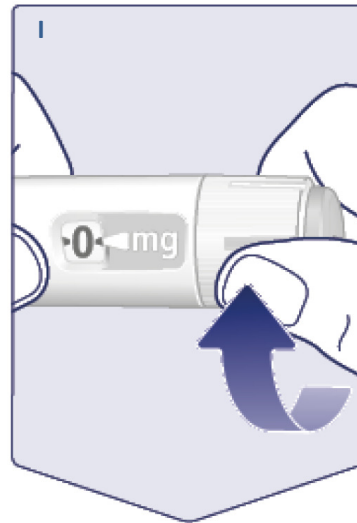

The dashed line (|) in the dose counter will guide you to your dose.

The dose selector clicks differently when turned forward, backwards or past your dose. You will hear a 'click' every time you turn the dose selector. Do not set the dose by counting the number of clicks you hear.

(See figure J).

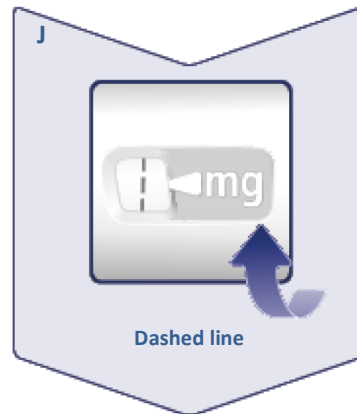

When your prescribed dose lines up with the dose pointer, you have selected your dose. In this picture, the dose 0.25 mg is shown as an example.

If the dose counter stops before you reach your prescribed dose, see the section '**Do you have enough Wegovy?**' below these instructions.

(See figure K).

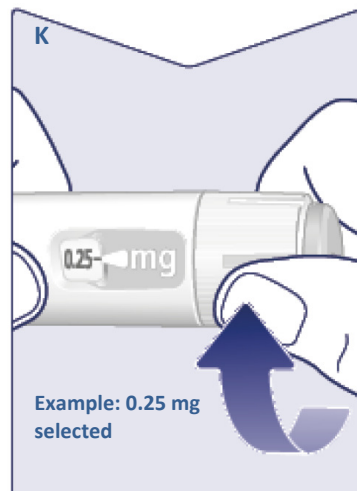

Choose your injection site

Choose your upper arms, upper legs or stomach (keep a 5 cm distance from your belly button).

You may inject in the same body area each week, but make sure it is not in the same spot as used the last time.

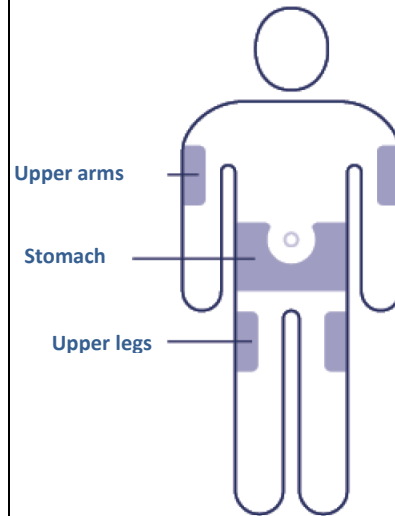

3 Inject your dose

Insert the needle into your skin.

Make sure you can see the dose counter. Do not cover it with your fingers. This could interrupt the injection.

(See figure L).

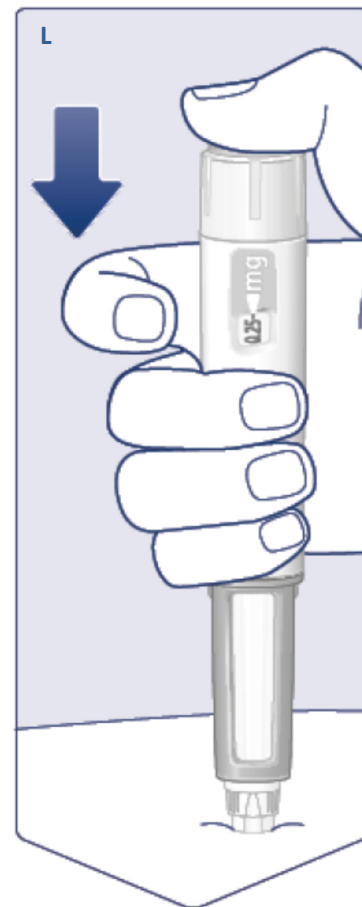

Press and hold down the dose button until the dose counter shows 0.

(See figure M).

Keep pressing the dose button with the needle in your skin and slowly count to 6.

The 0 must line up with the dose pointer. You may hear or feel a click when the dose counter returns to 0.

(See figure N).

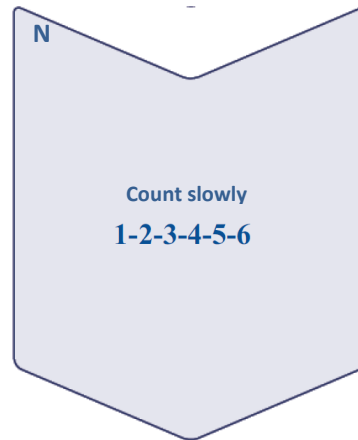
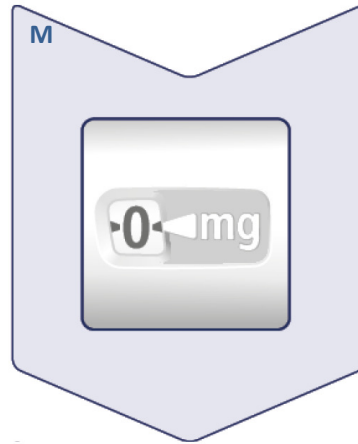

Remove the needle from your skin. If the needle is removed earlier, a stream of Wegovy may come from the needle tip and the full dose will not be delivered.

If blood appears at the injection site, press lightly on the area to stop the bleeding.

You may see a drop of Wegovy at the needle tip after injecting. This is normal and does not affect your dose.

(See figure O).

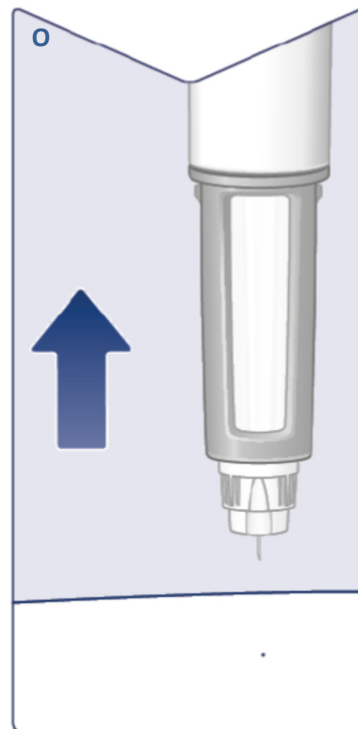

4 After your injection

Lead the needle tip into the outer needle cap on a flat surface without touching the needle or the outer needle cap.

Once the needle is covered, carefully push the outer needle cap completely on.

(See figure P).

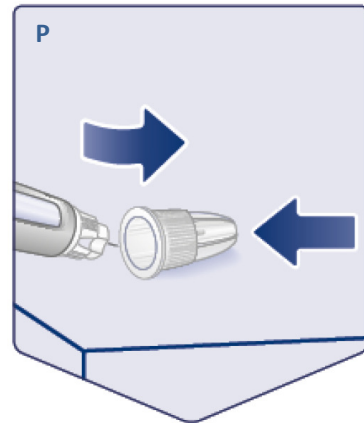



Unscrew the needle and dispose of it carefully as instructed by your doctor, nurse, pharmacist or local authorities.

Never try to put the inner needle cap back on the needle. You may stick yourself with the needle.

Always dispose of the needle immediately after each injection to prevent blocked needles, contamination, infection, and inaccurate dosing. **Never store your pen with the needle attached.**

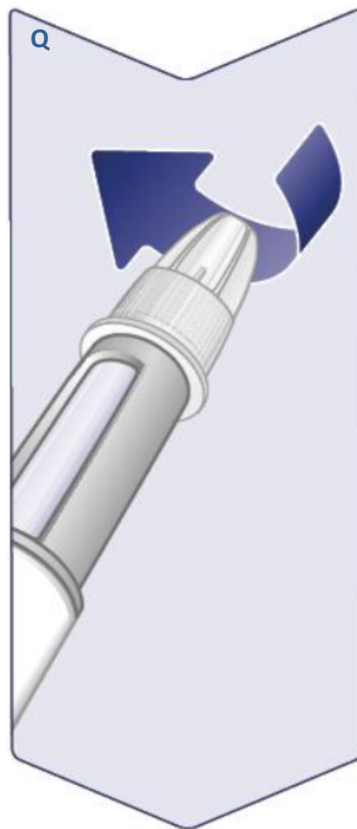
(See figure Q).



<p>Put the pen cap on your pen after each use to protect Wegovy from light.</p> <p>(See figure R).</p>	
<p>When the pen is empty, dispose of the pen without a needle on as instructed by your doctor, nurse, pharmacist, or local authorities.</p> <p>The pen cap and the empty carton can be disposed of in your household waste.</p>	
<p>About your needles</p>	
<p>How to identify a blocked or damaged needle</p> <ul style="list-style-type: none"> • If 0 does not appear in the dose counter after continuously pressing the dose button, you may have used a blocked or damaged needle. • In this case, you have not received any Wegovy – even though the dose counter has moved from the original dose that you have set. <p>How to handle a blocked needle</p> <ul style="list-style-type: none"> • Change the needle as instructed in ‘1 Prepare your pen with a new needle’ and go to ‘2 Set your dose’. 	

Caring for your pen

Treat your pen with care. Rough handling or misuse may cause inaccurate dosing. If this happens, you might not get the intended effect of Wegovy.

- See section 5 in this leaflet to read the storage conditions for your pen.
- **Do not inject Wegovy that has been exposed to direct sunlight.**
- **Do not subject Wegovy to frost and never inject Wegovy that has been frozen.** Dispose of the pen.
- **Do not drop your pen** or knock it against hard surfaces.
- **Do not try to refill your pen.** Once empty, it must be disposed of.
- **Do not try to repair your pen** or pull it apart.
- **Do not expose your pen to dust, dirt or liquid.**
- **Do not wash, soak or lubricate your pen.** If necessary, clean it with a mild detergent on a moistened cloth.

Do you have enough Wegovy?

If the dose counter stops before you reach your prescribed dose, there is not enough Wegovy left for a full dose. Dispose of the pen and use a new Wegovy pen.

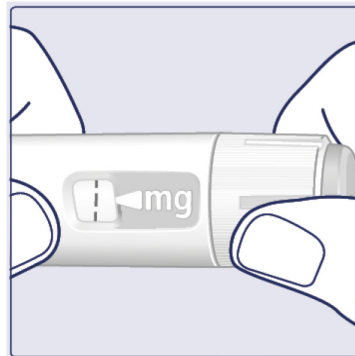

 **Important information**

- **Only inject one dose of Wegovy once weekly.** If you do not use your Wegovy as prescribed, you may not get the intended effect of this medicine.
- If you use more than one type of injectable medicine, it is **very important to check the name and dose** of your pen label **before use**.
- **Do not use this pen without help if you have poor eyesight and cannot follow these instructions.** Get help from a person with good eyesight who is trained to use the Wegovy pen.
- Always keep pen and needles **out of sight and reach of others, especially children**.
- **Never share** your pen or your needles with other people.
- **Needles are for single use only. Never reuse your needles** as it may lead to blocked needles, contamination, infection and inaccurate dosing.
- Caregivers must **be very careful when handling used needles** to prevent accidental needle stick injuries and infection.