

**Patient leaflet in accordance with the Pharmacists' Regulations (Preparations) - 1986**

This medicine is dispensed with a doctor's prescription only

# **Tremfya<sup>®</sup> 100 mg/ml S.C.**

**solution for injection in pre-filled syringe, 1 ml**  
**solution for injection in pre-filled pen, 1ml**

Each pre-filled syringe or pen contains:  
Guselkumab 100 mg/1 ml

For information about inactive ingredients and allergens in this medicine - see section 2 under 'Important information about some of this medicine's ingredients', and section 6 'Additional information'.

**Read the entire leaflet carefully before you start using this medicine.** This leaflet contains concise information about this medicine. If you have any further questions, consult your doctor or pharmacist. Keep the leaflet. You may need to read it again. This medicine has been prescribed for you. Do not pass it on to others. It may harm them, even if it seems to you that their medical condition is similar to yours.

## **1. What is this medicine intended for?**

### Plaque psoriasis

Tremfya is intended for the treatment of moderate to severe plaque psoriasis in adult patients who are candidates for systemic treatment or phototherapy.

### Psoriatic arthritis

Tremfya, alone or in combination with methotrexate, is indicated for the treatment of active psoriatic arthritis in adult patients who have had an inadequate response or who have been intolerant to a prior disease-modifying drug (DMARD) therapy.

### Ulcerative colitis

Tremfya is intended for the treatment of adult patients with moderately to severely active ulcerative colitis who have had an inadequate response, lost response, or were intolerant to either conventional therapy or a biologic treatment.

### Crohn's disease

Tremfya is intended for the treatment of adult patients with moderately to severely active Crohn's disease who have had an inadequate response, lost response, or were intolerant to either conventional therapy or a biologic treatment.

### **Therapeutic group:**

Interleukin inhibitors.

### **How Tremfya works?**

Tremfya contains the active ingredient guselkumab, which is a type of protein called a monoclonal antibody. This medicine works by blocking the activity of a protein called IL-23,

which is present at high levels in people with psoriasis, psoriatic arthritis, ulcerative colitis and Crohn's disease.

In plaque psoriasis - the medicine can improve the condition of the skin and appearance of the nails and reduce symptoms, such as scaling, shedding, flaking, itching, pain and burning sensation.

In psoriatic arthritis - the medicine can improve the signs and symptoms of the disease, slow down the damage to the cartilage and bones of the joints and improve your ability to perform daily activities.

### Ulcerative colitis

Colitis is an inflammatory disease of the bowel. If you have ulcerative colitis, you will first be given other medicines. If you do not respond well enough or cannot tolerate these medicines, you may be given Tremfya. Using Tremfya in ulcerative colitis can benefit you by reducing the signs and symptoms of the disease including bloody stools, the need to rush to and the number of times you go to the toilet, abdominal pain and the inflammation of your intestinal lining. These effects can improve your ability to do normal daily activities and reduce fatigue.

### Crohn's disease

Crohn's disease is an inflammatory disease of the bowel. If you have Crohn's disease, you will first be given other medicines. If you do not respond well enough or cannot tolerate these medicines, you may be given Tremfya. Using Tremfya in Crohn's disease can benefit you by reducing the signs and symptoms of the disease including diarrhoea, abdominal pain, and the inflammation of your intestinal lining. These effects can improve your ability to do normal daily activities and reduce fatigue.

## **2. Before using this medicine**

### **Do not use this medicine if:**

- You are sensitive (allergic) to guselkumab or to any of the other ingredients in this medicine (as listed in section 6 – 'Additional information'). If you think you may be allergic, ask your doctor for advice before using this medicine.
- You have an active infection, including active tuberculosis.

### **Special warnings about using this medicine**

#### **Before treatment with Tremfya, tell your doctor if:**

- you are being treated for an infection you have.
- you have an infection that does not go away, or the infection keeps coming back.
- you have tuberculosis or have been in close contact with someone with tuberculosis.
- you think you have an infection or have symptoms of an infection (see below under 'Look out for infections and allergic reactions').
- you have recently had a vaccination or if you are planning to have a vaccination during treatment with Tremfya.

If you are not sure if any of the above sections applies to you, consult your doctor, pharmacist or nurse before using this medicine.

### **Look out for infections and allergic reactions**

Tremfya may cause serious side effects, including allergic reactions and infections. You must look out for signs of these conditions while you are taking Tremfya.

Signs or symptoms of infections may include fever or flu-like symptoms; muscle aches; cough; shortness of breath; stinging/burning when you urinate or urinating more often than usual; blood in your phlegm; weight loss; diarrhoea or stomach pain; warm, red or painful skin or sores on your body which are different from psoriasis.

Serious allergic reactions have occurred with Tremfya. Symptoms may include swollen face, lips, mouth, tongue or throat, difficulty swallowing or breathing, lightheadedness or dizziness, or hives (see 'Serious side effects' in section 4 'Side effects').

Stop using Tremfya and tell your doctor or seek medical help **immediately** if you notice any signs indicating a possible serious allergic reaction or an infection.

### **Children and adolescents**

Tremfya is not recommended for children and adolescents under 18 years of age because it has not been studied in these age groups.

### **Tests and follow-up**

As directed by your doctor, you may need to have blood tests to check if you have high levels of liver enzymes before and while you use Tremfya. Increases in liver enzymes may appear more frequently in patients receiving Tremfya every 4 weeks than in patients receiving Tremfya every 8 weeks (see also section 3 – 'How to use this medicine?').

### **Interactions with other medicines**

**If you are taking, or have recently taken, other medicines, including nonprescription medicines and dietary supplements, tell your doctor or pharmacist.**

Additionally, if you recently had or are due to have a vaccination, inform your doctor. You should not receive certain type of vaccines (live vaccine) while being treated with Tremfya.

### **Pregnancy, breast-feeding and fertility**

#### Pregnancy

Do not use this medicine during pregnancy, as the effect of this medicine in pregnant women is not known. Women of childbearing potential are advised to avoid becoming pregnant and to use contraception during the course of treatment with the medicine and for at least 12 weeks after taking the last Tremfya dose.

Talk to your doctor if you are pregnant, think you may be pregnant or are planning to become pregnant.

#### Breast-feeding

Talk to your doctor if you are breast-feeding or are planning to breast-feed. You and your doctor should decide if you will breast-feed or use Tremfya.

### **Driving and using machines**

It is unlikely that Tremfya will affect your ability to drive and operate machinery.

### **Important information about some of this medicine's ingredients**

#### **Tremfya contains polysorbate 80**

This medicine contains 0.5 mg of polysorbate 80 in each pre-filled pen/syringe, which is equivalent to 0.5 mg/ml.

Polysorbate may cause allergic reactions. Tell your doctor if you have any known allergies.

This medicine contains sucrose. Also see section 6 – 'Additional information'.

### **3. How to use this medicine?**

Always use this medicine according to your doctor's instructions.

Check with your doctor or pharmacist if you are not sure about your dose or about how to take

this medicine.

### **What dosage of the medicine is given, and for how long?**

Only your doctor will determine your dose and how you should take this medicine. The recommended dosage is usually:

#### Plaque psoriasis:

- The dose of the medicine is 100 mg (the contents of one pre-filled syringe or pen), given as an injection under the skin. The treatment will be administered by a doctor or nurse.
- The second dose will be administered 4 weeks after administration of the first dose. Afterwards, a dose will be given every 8 weeks.

#### Psoriatic arthritis:

- The dosage of the medicine is 100 mg (the contents of one pre-filled syringe or pen) given as an injection under the skin. The treatment will be administered by a doctor or nurse.
  - The second dose will be administered 4 weeks after administration of the first dose. Afterwards, a dose will be given every 8 weeks.
- In certain patients, after administration of the first dose, a dose of Tremfya will be given every 4 weeks. Your doctor will decide how often you will receive Tremfya.

#### Ulcerative colitis:

##### **Treatment start:**

The first dose of Tremfya is 200 mg, and it will be given by your doctor or nurse by intravenous infusion (drip in a vein in your arm). After the first dose, you will receive a second dose 4 weeks later and then a third dose after an additional 4 weeks.

##### **Maintenance therapy:**

A maintenance dose of Tremfya, 100 mg or 200 mg, will be given by injection under the skin (subcutaneous injection). Your doctor will determine which maintenance dose you will receive.

- A dose of 100 mg will be given 8 weeks after the third treatment start dose, and then every 8 weeks.
- A dose of 200 mg will be given 4 weeks after the third treatment start dose, and then every 4 weeks.

#### Crohn's disease:

##### **Treatment start:**

Treatment start can be given either by intravenous infusion or by subcutaneous administration:

- Intravenous infusion: The first dose of Tremfya is 200 mg, and it will be given by your doctor or nurse by intravenous infusion (drip in a vein in your arm). After the first dose, you will receive a second dose 4 weeks later and then a third dose after an additional 4 weeks.
- Subcutaneous administration: The first dose of Tremfya is 400 mg and will be given under the skin (subcutaneous injection) at different sites of the body. After the first dose, you will receive a second dose 4 weeks later and then a third dose after an additional 4 weeks.

##### **Maintenance therapy:**

A maintenance dose of Tremfya, 100 mg or 200 mg, will be given by injection under the skin (subcutaneous injection). Your doctor will determine which maintenance dose you will receive:

- A dose of 100 mg will be given 8 weeks after the third treatment start dose, and then every 8 weeks.

- A dose of 200 mg will be given 4 weeks after the third treatment start dose, and then every 4 weeks.

### **Do not exceed the recommended dose.**

You may decide together with your doctor that you are able to inject the medicine yourself. In this case, you will receive training on the right way to inject Tremfya. Talk to your doctor or nurse if you have any questions about self-injecting the medicine. It is important not to try to inject the medicine yourself until you have been trained by your doctor or nurse.

For detailed description of the instructions for use, carefully read the 'How to use' section below.

Use this medicine at set intervals, as determined by your doctor. Adhere to the treatment as recommended by your doctor. Even if your health improves, do not stop the treatment with Tremfya without consulting your doctor.

### **If you have accidentally taken or received a higher dose or received the medicine earlier than prescribed by your doctor:**

Contact your doctor immediately.

If a child has accidentally swallowed some medicine, immediately see a doctor or go to a hospital emergency room and bring the medicine package with you.

### **If you forget to take the medicine:**

If you have forgotten to inject a dose of Tremfya, contact your doctor.

### **If you stop treatment with this medicine:**

Do not stop treatment with this medicine without consulting your doctor. If you stop the treatment, the disease symptoms may recur.

**Do not take medicines in the dark! Check the label and dose every time you take medicine. Wear glasses if you need them.**

**If you have any further questions about using this medicine, consult your doctor or pharmacist.**

## **4. Side effects**

As with any medicine, using Tremfya may cause side effects in some users. Do not be alarmed by this list of side effects. You may not experience any of them.

### **Serious side effects**

Tell your doctor or seek medical help immediately if any of the following side effects appears: **Possible serious allergic reactions (appear in 1 in 100 users)** – the signs or symptoms may include:

- difficulty breathing or swallowing
- swelling of the face, lips, tongue or throat
- severe itching of the skin, with a red rash or raised bumps
- lightheadedness, low blood pressure or dizziness

### **Additional side effects**

The following side effects are mild to moderate. If any of these side effects becomes severe, tell your doctor, pharmacist or nurse immediately.

### **Very common side effects (effects that appear in more than one in ten users)**

- respiratory tract infections

### **Common side effects (effects that appear in 1-10 in 100 users)**

- headache
- joint pain (arthralgia)
- diarrhoea
- increased level of liver enzymes in the blood
- skin rash

### **Uncommon side effects (effects that appear in 1-10 in 1,000 users)**

- decreased number of a type of white blood cell called neutrophils
- herpes simplex infections
- fungal infection of the skin, for instance between the toes (e.g., athlete's foot)
- stomach flu (gastroenteritis)
- urticaria (hives)
- redness, irritation or pain at the injection site

### **Rare side effects (effects that appear in 1-10 in 10,000 users)**

- allergic reaction

**If you experience any side effect, if any side effect gets worse, or if you experience a side effect not mentioned in this leaflet, consult your doctor.**

### **Reporting side effects**

You can report side effects to the Ministry of Health by following the 'Reporting Side Effects of Drug Treatment' link on the Ministry of Health home page ([www.health.gov.il](http://www.health.gov.il)), which opens an online form for reporting side effects, or you can also use this link:

<https://sideeffects.health.gov.il>

## **5. How to store the medicine?**

- Prevent poisoning! To prevent poisoning, keep this and all other medicines in a closed place, out of the reach and sight of children and/or infants. Do not induce vomiting unless explicitly instructed to do so by your doctor.
- Do not use the medicine after the expiry date (exp. date) which is stated on the package. The expiry date refers to the last day of that month.
- Store in a refrigerator at 2°C-8°C. Do not freeze.
- Keep the pre-filled syringe or pen in the outer carton in order to protect from light.
- Do not shake.
- Do not use this medicine if you notice that the solution is cloudy, discoloured or contains large particles.
- Before use, remove the carton from the refrigerator. Keep the pre-filled syringe or pen inside the carton until it reaches room temperature by waiting for 30 minutes.
- This medicine is intended for single use only.
- Do not throw away any medicine via wastewater or household waste. Ask the pharmacist how to dispose of medicines that are no longer needed. These measures will help protect the environment.

## **6. Additional information**

Tremfya contains the active ingredient guselkumab, with a pre-filled syringe or pen containing 100 mg active ingredient in 1 ml solution.

**In addition to the active ingredient, this medicine also contains:**

Sucrose, L-Histidine monohydrochloride monohydrate, L-Histidine, Polysorbate 80 (E433), Water for injection.

Sucrose content – 79 mg.

**What the medicine looks like and contents of the pack:**

Tremfya is a clear and colourless to light yellowish solution. Each box contains one pre-filled syringe or one pre-filled pen.

**Manufacturer's name and address:**

Janssen Cilag-International NV  
Turnhoutseweg 30, B-2340, Beerse, Belgium.

**Registration holder's name and address:** J-C Health Care Ltd., Kibbutz Shefayim 6099000, Israel.

**Registration number of the medicine in the Ministry of Health's National Drug Registry:**

160-54-35346

Revised in September 2025.

## **HOW TO USE:**

Please find below separate instructions for use for the pre-filled syringe and then separate instructions for use for the pre-filled pen.

## **INSTRUCTIONS FOR USE OF TREMFYA 100 MG PRE-FILLED SYRINGE:**

### **Important information**

If your doctor decides that you or your caregiver can inject Tremfya at home, you will have to receive training by a healthcare professional on the right way to use, prepare and inject Tremfya using the pre-filled syringe (see illustration 1) before you can inject the medicine by yourself.

Read the instructions for use of the pre-filled syringe before each injection. The guidelines may be updated from time to time. This leaflet is not a substitute for consultation with the doctor regarding your medical condition or your treatment. Carefully read the Tremfya patient leaflet before the injection. If you have questions, refer to a doctor or nurse.

Tremfya pre-filled syringe is intended for injection under the skin, **and not** for injection into the muscle or vein. After injection, the needle will retract into the body of the syringe and lock into place.

### **Storage conditions**

Store in a refrigerator (2°C-8°C). **Do not freeze.**

**Keep your pre-filled syringe in the outer carton to protect from light and physical damage.**

**Keep out of reach and sight of children.**

**Do not** shake the pre-filled Tremfya syringe at any stage.

Keep the pre-filled syringe in the outer carton in order to protect from light.

### **Pre-filled syringe parts**

#### **Before use:**

See illustration 2.

#### **After use:**

See illustration 3.

### **Supplies you will need for the injection:**

1 pre-filled Tremfya syringe.

### **Supplies not included in the Tremfya syringe pack:**

1 alcohol swab/wipe

1 cotton ball or gauze pad

1 adhesive bandage

1 sharps container (see step 3).

## **1. PREPARING FOR INJECTION**

### **Inspecting the carton** (see illustration 4)

Take the box of the pre-filled Tremfya syringe out of the refrigerator.

Leave the pre-filled syringe in the box and place it on a flat surface at room temperature for **at least 30 minutes** before use.

**Do not** warm the pre-filled syringe in any other way.

**Check the expiration date ('EXP')** on the back of the carton. The expiry date refers to the last day of that month. **Do not** use the syringe if the expiry date has passed.

**Do not** use Tremfya if the box is not intact/is not closed well.

Contact the doctor or pharmacist who dispensed the medicine to you.

### **Choosing the injection site** (see illustration 5)

Select from the following areas for your injection:

- **Front of thigh** (recommended).
- Lower abdominal area, at a distance of **at least 5 centimeters** from the navel.
- Back of upper arms (only if a healthcare professional or caregiver is giving you the injection).

**Do not** inject into skin that is tender, bruised, red, scaly or hard.

**Do not** inject into areas with scars or stretch marks.

### **Cleaning the injection site** (see illustration 6)

Wash your hands thoroughly with soap and hot water.

Wipe the selected injection site with an alcohol swab and allow it to dry.

**Do not** touch, fan or blow on the injection site after you have cleaned it.

### **Inspecting the liquid in the syringe** (see illustration 7)

Take the pre-filled Tremfya syringe out of the box.

Check the syringe liquid in the viewing window. Make sure the liquid in the syringe is clear to slightly yellow. The liquid may contain tiny, partly clear or white particles. You may also see one or more air bubbles. This is normal.

**Do not** use if the liquid is discoloured or cloudy or contains large particles. If you are uncertain, contact the doctor or the pharmacist who dispensed this medicine to you.

## **2. INJECTING TREMFYA USING THE PRE-FILLED SYRINGE**

### **Removing the needle cover** (see illustration 8)

Hold the body of the syringe with one hand and pull the needle cover outward with your other hand. You may notice a drop of liquid at the tip of the needle – this is normal.

**Inject Tremfya within 5 minutes of removing the needle cover.**

**Do not** put the needle cover back on, as this may damage the needle.

**Do not** touch the needle and do not let the needle touch any surface.

**Do not** use the pre-filled syringe if it has fallen. In such a situation, contact the doctor or the pharmacist who dispensed the medicine to you.

### **Positioning the fingers and inserting the needle** (see illustration 9)

Place your thumb, index and middle fingers **directly under the finger flange**, as can be seen in the illustration.

**Do not** touch the finger flange or the area above it as this may cause the needle safety device to activate.

With the other hand, gently pinch the skin at the injection site. Position the syringe at a 45-degree angle to the skin.

It is important to pinch enough skin to enable **injection under the skin** and not into the muscle. Insert the needle of the syringe with a quick motion.

### **Releasing the pinch and repositioning the hand** (see illustration 10)

Use your free hand to grasp the body of the pre-filled syringe.

### **Pressing the plunger of the syringe** (see illustration 11)

Place the thumb from the other hand on the plunger **and press the plunger all the way down until it stops.**

### **Releasing the thumb from the plunger** (see illustration 12)

The safety guard will cover the needle and lock into place, while the needle is being removed from the skin.

## **3. AFTER THE INJECTION**

### **Discarding the used syringe** (see illustration 13)

Discard the used Tremfya syringe into a sharps disposal container, immediately after completing use.

When the container is full, dispose of the container according to the instructions you received from the doctor or nurse.

Do not throw away (dispose of) your pre-filled syringe in your household waste.

### **Check the injection site** (see illustration 14)

You may notice a small amount of blood or liquid at the injection site. Place a cotton ball or gauze pad on the injection site and press until the bleeding has fully stopped. **Do not** rub the area. If needed, place an adhesive bandage on the area.

The injection is now complete!

For further information, refer to your doctor or pharmacist.

## **INSTRUCTIONS FOR USE OF TREMFYA 100 MG PRE-FILLED PEN:**

### **Single-use device**

#### **Important information**

If your doctor decides that you or your caregiver can inject Tremfya at home, you will have to receive training by a healthcare professional on the right way to use, prepare and inject Tremfya using the pre-filled pen (see illustration 15), before you can inject the medicine by yourself.

Read the instructions for use of the pre-filled pen before each injection and each time you get a new pen. The guidelines may be updated from time to time. This leaflet is not a substitute for consultation with the doctor regarding your medical condition or your treatment.

Carefully read the Tremfya Patient Leaflet as well before your injection. If you have any questions, refer to your doctor or nurse.

**During the injection, push the handle all the way down, until the green body is not visible, to inject the full dose.**

**DO NOT LIFT THE PRE-FILLED PEN during the injection. If you do, the pre-filled pen will lock and you will not get the full dose.**

#### **Storage conditions**

Store in a refrigerator (2°C-8°C). **Do not** freeze.

**Do not** shake the pre-filled pen at any stage.

**Keep Tremfya and any other medicine out of reach and sight of children.**

**Keep the pre-filled pen in the outer carton in order to protect from light and physical damage.**

**Pre-filled pen parts** (see illustration 16)

**Supplies you will need:**

- 1 alcohol swab/wipe
- 1 cotton ball or gauze pad
- 1 adhesive bandage
- 1 sharps container (see step 3).

**1. PREPARING FOR INJECTION**

**Inspect the carton and wait until Tremfya reaches room temperature** (see illustration 17).

Take the box of the pre-filled Tremfya pen out of the refrigerator.

Leave the pre-filled pen in the box and place it on a flat surface at room temperature for approximately **30 minutes** before use.

**Do not** warm the pre-filled pen in any other way.

**Check the expiration date ('EXP')** on the back of the carton (see illustration 18). The expiry date refers to the last day of that month. **Do not** use the pre-filled pen if the expiry date has passed.

**Do not** use Tremfya if the box is not intact/is not closed well.

Contact the doctor or pharmacist who dispensed the medicine to you.

**Choosing the injection site** (see illustration 19)

Select from the following areas for your injection:

- **Front of thigh** (recommended).
- Lower abdominal area. At a distance of **at least 5 centimeters** from the navel.
- Back of upper arms (only if a healthcare professional or caregiver is giving you the injection).

**Do not** inject into skin that is tender, bruised, red, scaly, hard or into areas with scars or stretch marks.

**Washing hands** (see illustration 20)

Wash your hands thoroughly with soap and hot water.

**Cleaning the injection site**

Wipe the selected injection site with an alcohol swab and allow it to dry.

Do not touch fan or blow on the injection site after you have cleaned it.

**Inspecting the liquid in the pen** (see illustration 21)

Take the Tremfya pre-filled pen out of the box.

Check the liquid in the viewing window of the pen. Make sure the liquid in the pen is clear to slightly yellow. The liquid may contain tiny, partly clear or white particles. You may also see one or more air bubbles.

This is normal.

**Do not** use if the liquid is:

- cloudy, or
- discoloured, or
- contains large particles

If you are uncertain, contact the doctor or the pharmacist who dispensed the medicine to you.

**2. INJECTING TREMFYA USING THE PRE-FILLED PEN**

**Pull off the bottom cap of the pen when you are ready to inject** (see illustration 22)

Keep hands away from the needle guard after the cap is removed. It is normal to see a few drops of liquid.

**Inject Tremfya within 5 minutes of removing the cap.**

**Do not** put the cap back on. This may damage the needle.

**Do not** use the pre-filled pen if it has fallen after removing the cap. In such a situation, contact the doctor or the pharmacist who dispensed the medicine to you.

Place **the pen** straight on the skin (see illustration 23)

Push **the pen** handle all the way down until green body is not visible (see illustration 23)

**DO NOT LIFT THE PRE-FILLED PEN DURING THE INJECTION!**

If you do, the needle guard will lock, showing a yellow band, and you will not get the full dose.

You may hear a “click” when the injection begins. Keep pushing.

**If you feel resistance, keep pushing. This is normal.**

The medication injects as you push. Do this at a speed that is comfortable for you.

**Confirm injection is complete** (see illustration 24)

Injection is complete when:

- **The green body is no longer visible**
- You cannot press the handle down anymore
- You may hear a “click”

**Lift the pen upwards** (see illustration 25)

The yellow band indicates that the needle guard is locked.

### **3. AFTER THE INJECTION**

**Discard the used pen** (see illustration 26)

Discard the used Tremfya pen into a sharps disposal container immediately after use.

Make sure you dispose of the container as instructed by your doctor or nurse when it is full.

**Do not throw away** the pre-filled pen in your household waste.

**Do not recycle** the used sharps disposal container.

**Check the injection site** (see illustration 27)

You may notice a small amount of blood or liquid at the injection site. Place a cotton ball or gauze pad on the injection site and press until the bleeding has fully stopped.

**Do not** rub the area. If needed, place an adhesive bandage on the area.

The injection is now complete!

For further information, refer to your doctor or pharmacist.

## **Pre-filled syringe**

Tremfya 100mg/ml SC- PL- 09.2025

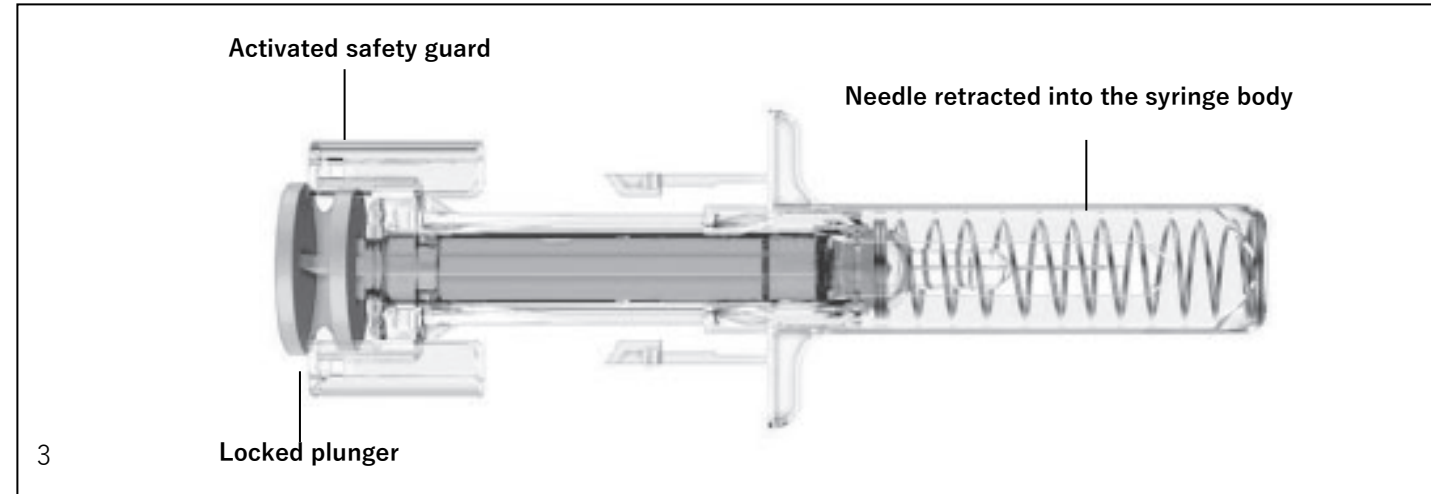
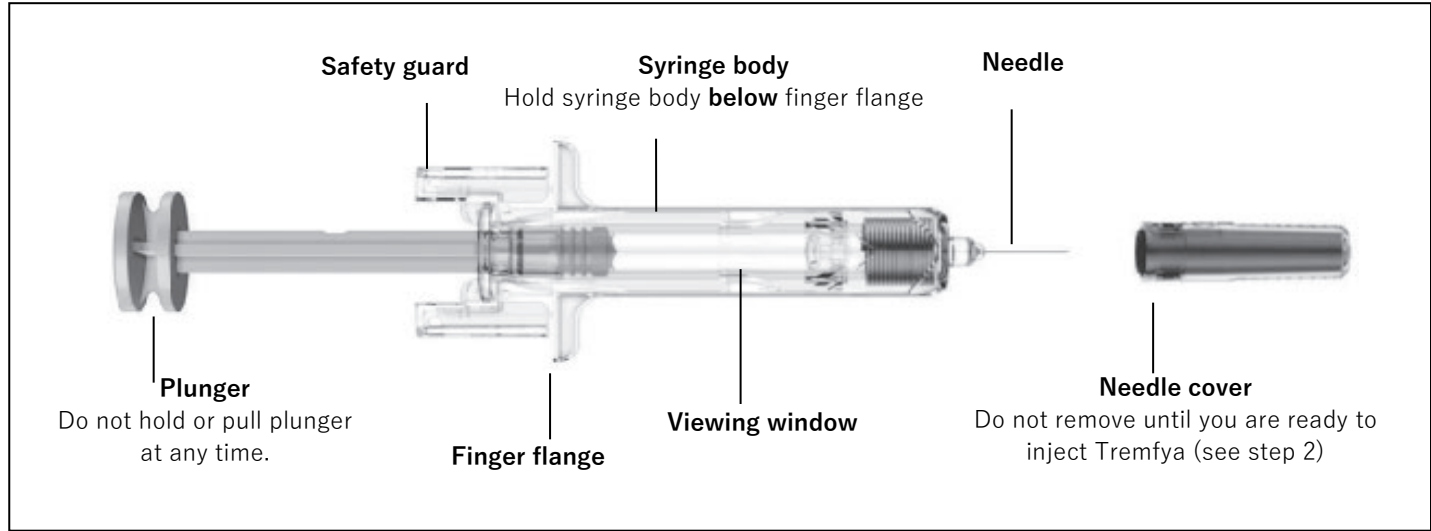
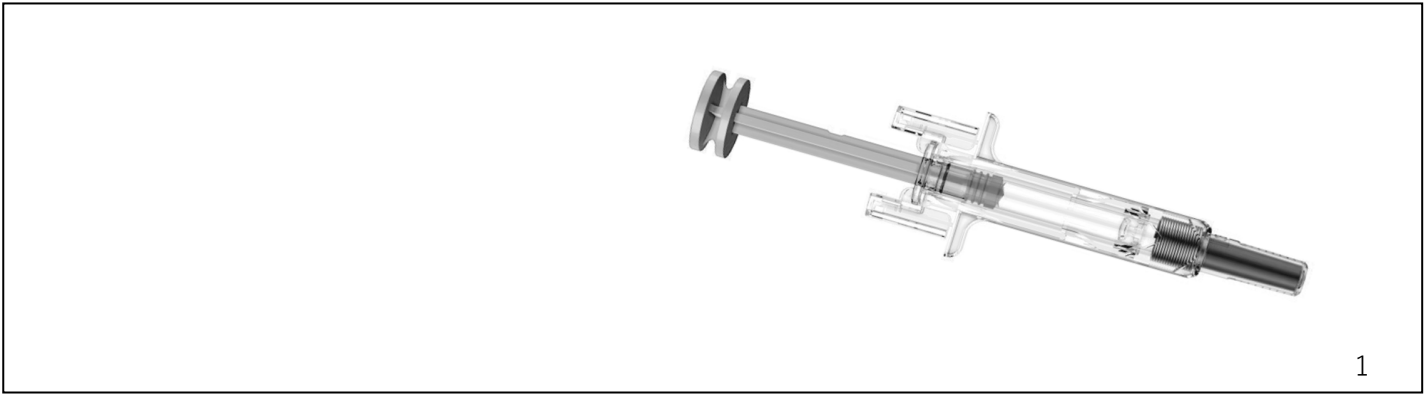

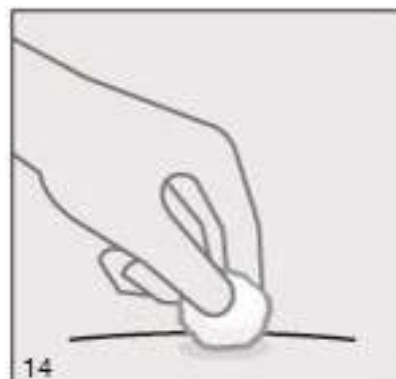
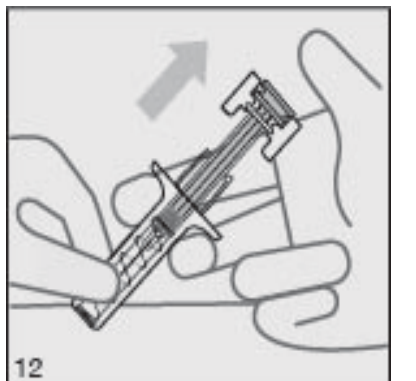
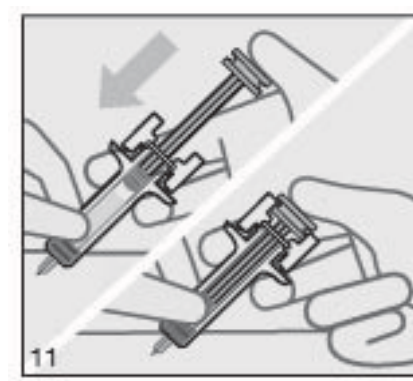
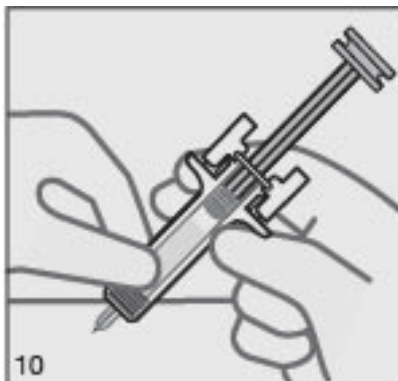
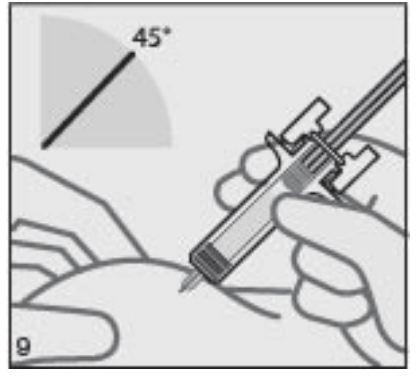
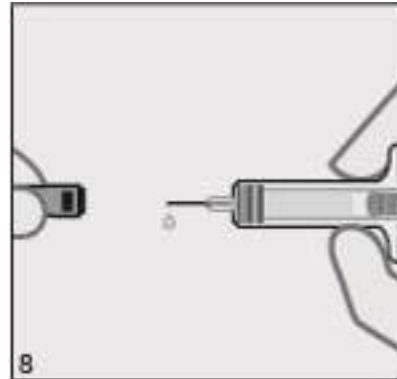
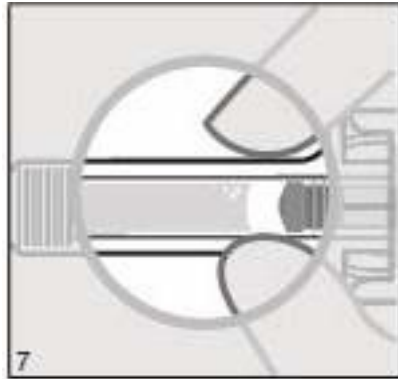
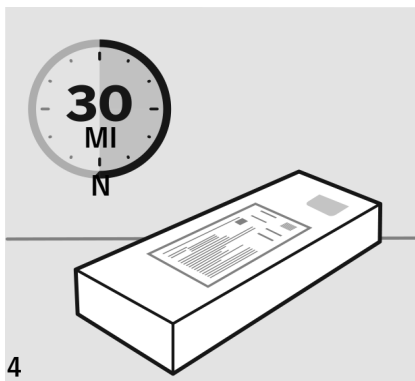

## Pre-filled pen

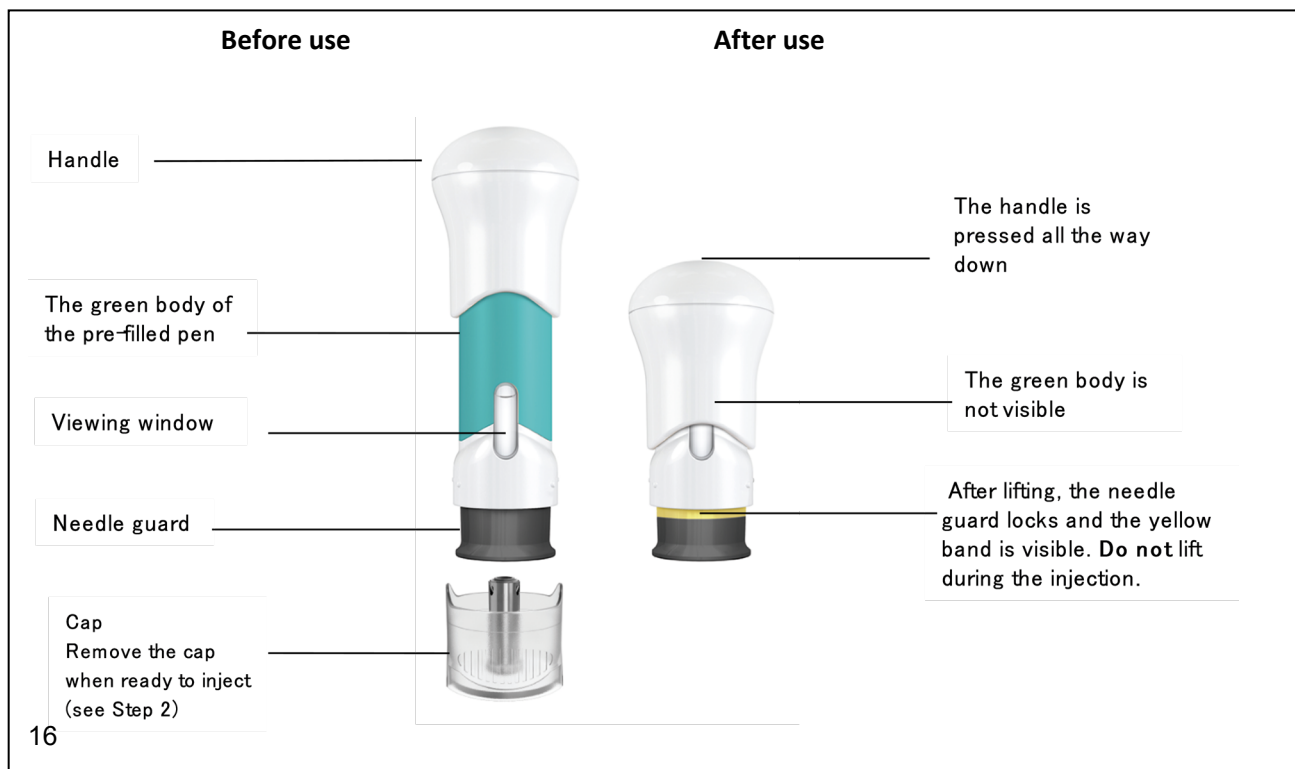
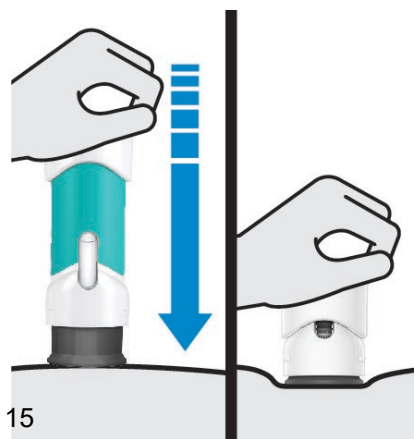

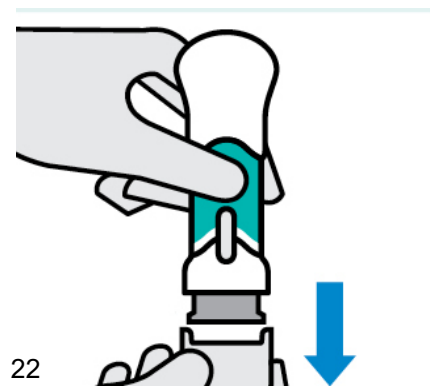
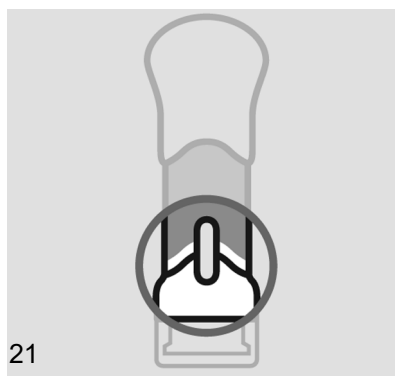
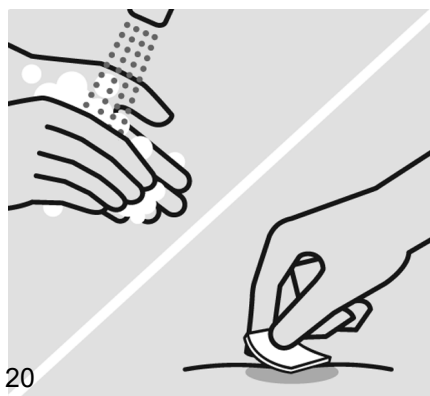
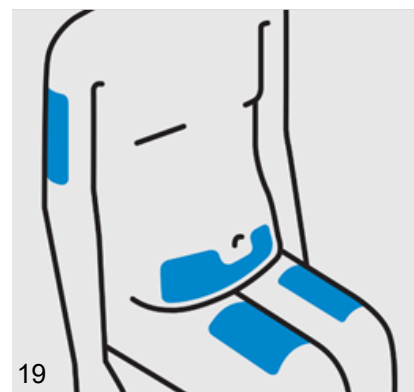
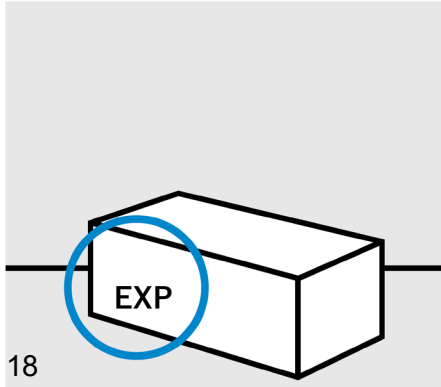
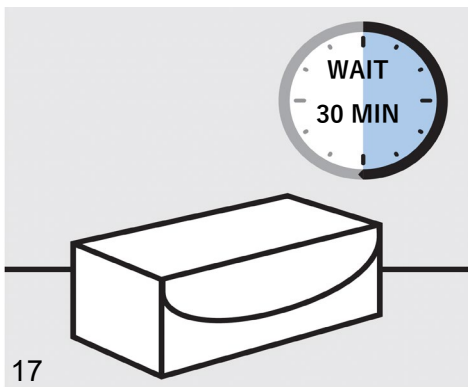

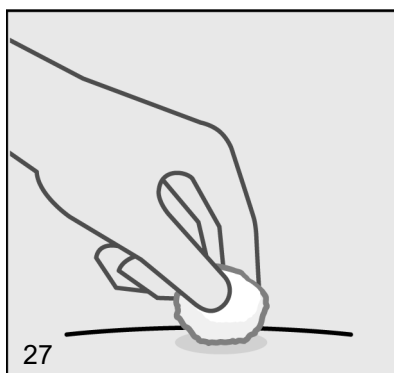
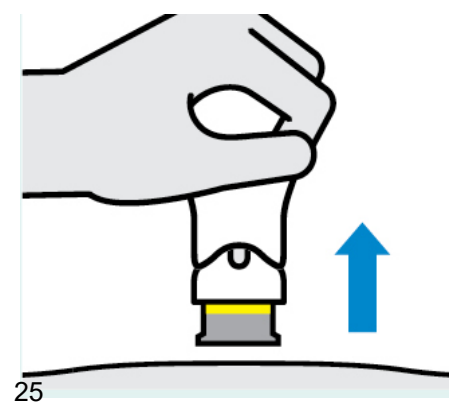
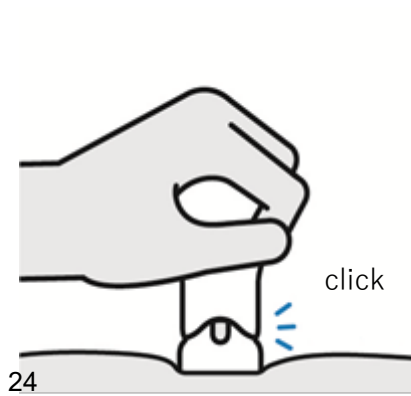
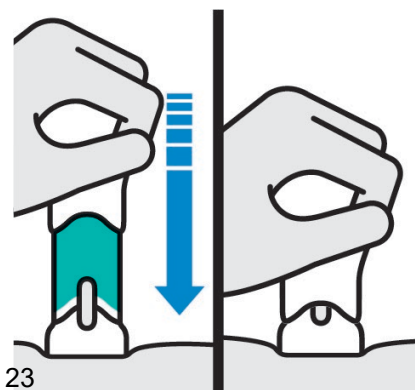

**Patient leaflet in accordance with the Pharmacists' Regulations (Preparations) - 1986**

This medicine is dispensed with a doctor's prescription only

# **Tremfya<sup>®</sup> 100 mg/ml S.C.**

## **solution for injection in pre-filled syringe/pre-filled pen, 2 ml**

Each pre-filled syringe or pen contains:  
guselkumab 200 mg/2 ml

For information about inactive ingredients and allergens in this medicine, see section 2 under 'Important information about some of this medicine's ingredients', and section 6 'Additional information'.

**Read the entire leaflet carefully before you start using this medicine.** This leaflet contains concise information about this medicine. If you have any further questions, consult your doctor or pharmacist.

This medicine has been prescribed for you. Do not pass it on to others. It may harm them, even if it seems to you that their medical condition is similar to yours.

### **1. What is this medicine intended for?**

#### Ulcerative colitis

Tremfya is intended for the treatment of adults with moderately to severely active ulcerative colitis who have had an inadequate response, lost response, or were intolerant to either conventional therapy or a biologic treatment.

#### Crohn's disease

Tremfya is intended for the treatment of adults with moderately to severely active Crohn's disease who have had an inadequate response, lost response, or were intolerant to either conventional therapy or a biologic treatment.

#### **Therapeutic group:**

Interleukin inhibitors.

#### **How Tremfya works?**

Tremfya contains the active ingredient guselkumab, which is a type of protein called a monoclonal antibody. This medicine works by blocking the activity of a protein called IL-23, which is present at high levels in people with ulcerative colitis and Crohn's disease.

#### Ulcerative colitis

Colitis is an inflammatory disease of the bowel. If you have ulcerative colitis, you will first be given other medicines. If you do not respond well enough or cannot tolerate these medicines, you may be given Tremfya. Using Tremfya in ulcerative colitis can benefit you by reducing the signs and symptoms of the disease including bloody stools, the need to rush to and the number of times you go to the toilet, abdominal pain and the inflammation of your intestinal lining. These effects can improve your ability to do normal daily activities and reduce fatigue.

#### Crohn's disease

Crohn's disease is an inflammatory disease of the bowel. If you have Crohn's disease, you will first be given other medicines. If you do not respond well enough or cannot tolerate these medicines, you may be given Tremfya. Using Tremfya in Crohn's disease can benefit you by reducing the signs and symptoms of the disease including diarrhoea, abdominal pain, and the inflammation of your intestinal lining. These effects can improve your ability to do normal daily activities and reduce fatigue.

## **2. Before using this medicine**

### **Do not use this medicine if:**

- You are sensitive (allergic) to guselkumab or to any of the other ingredients in this medicine (as listed in section 6 'Additional information'). If you think you may be allergic, ask your doctor for advice before using this medicine.
- You have an active infection, including active tuberculosis.

### **Special warnings about using this medicine**

#### **Before treatment with Tremfya, tell your doctor if:**

- you are being treated for an infection you have.
- you have an infection that does not go away, or the infection keeps coming back.
- you have tuberculosis or have been in close contact with someone with tuberculosis.
- you think you have an infection or have symptoms of an infection (see below under 'Look out for infections and allergic reactions').
- you have recently had a vaccination or if you are planning to have a vaccination during treatment with Tremfya.

If you are not sure if any of the above sections applies to you, consult your doctor, pharmacist or nurse before using this medicine.

### **Look out for infections and allergic reactions**

Tremfya may cause serious side effects, including allergic reactions and infections. You must look out for signs of these conditions while you are taking Tremfya.

Signs or symptoms of infections may include fever or flu-like symptoms, muscle aches, cough, shortness of breath, stinging/burning when you urinate or urinating more often than usual, blood in your phlegm, weight loss, diarrhoea or stomach pain, warm, red or painful skin or sores on your body.

Serious allergic reactions have occurred with Tremfya. Symptoms may include swollen face, lips, mouth, tongue or throat, difficulty swallowing or breathing, lightheadedness or dizziness, or hives (see 'Serious side effects' in section 4 'Side effects').

Stop using Tremfya and tell your doctor or seek medical help **immediately** if you notice any signs indicating a possible serious allergic reaction or an infection.

### **Children and adolescents**

Tremfya is not recommended for children and adolescents under 18 years of age because it has not been studied in these age groups.

### **Tests and follow-up**

As directed by your doctor, you may need to have blood tests to check if you have high levels of liver enzymes before and while you use Tremfya. Increases in liver enzymes may appear more frequently in patients receiving Tremfya every 4 weeks than in patients receiving Tremfya every 8 weeks (see also section 3 'How to use this medicine?').

## **Interactions with other medicines**

**If you are taking or have recently taken other medicines, including nonprescription medicines and dietary supplements, tell your doctor or pharmacist.**

Additionally, if you recently had or are due to have a vaccination, inform your doctor. You should not receive certain type of vaccines (live vaccine) while being treated with Tremfya.

## **Pregnancy, breast-feeding and fertility**

### Pregnancy

Do not use this medicine during pregnancy, as the effect of this medicine in pregnant women is not known. Women of childbearing potential are advised to avoid becoming pregnant and must use adequate contraception during treatment with this medicine and for at least 12 weeks after taking the last Tremfya dose.

Talk to your doctor if you are pregnant, think you may be pregnant or are planning to become pregnant.

### Breast-feeding

Talk to your doctor if you are breast-feeding or are planning to breast-feed. You and your doctor should decide if you will breast-feed or use Tremfya.

## **Driving and using machines**

Tremfya is unlikely to influence your ability to drive and use machines.

## **Important information about some of this medicine's ingredients**

### **Polysorbate 80**

This medicine contains 1 mg of polysorbate 80 in each pre-filled pen/syringe, which is equivalent to 0.5 mg/ml.

Polysorbate may cause an allergic reaction. Tell your doctor if you have any known allergies.

### **Sucrose**

This medicine contains sucrose.

If you have been told by your doctor that you have an intolerance to some sugars, talk your doctor before taking this medicine.

### **Sodium**

This medicine contains less than 1 mmol sodium (23 mg) per dose, that is to say essentially 'sodium free'.

## **3. How to use this medicine?**

Always use this medicine according to your doctor's instructions.

Check with your doctor or pharmacist if you are not sure about your dose or about how to take this medicine.

Only your doctor will determine your dose and how you should take this medicine. The recommended dosage is usually:

### Ulcerative colitis

Treatment start:

The first dose of Tremfya is 200 mg, and it will be given by your doctor or nurse by intravenous infusion (drip in a vein in your arm). After the first dose, you will receive a second dose 4 weeks later and then a third dose after an additional 4 weeks.

Maintenance therapy:

A maintenance dose of Tremfya, 100 mg or 200 mg, will be given by injection under the skin (subcutaneous injection). Your doctor will determine which maintenance dose you will receive.

- A dose of 100 mg will be given 8 weeks after the third treatment start dose, and then

every 8 weeks.

- A dose of 200 mg will be given 4 weeks after the third treatment start dose, and then every 4 weeks.

### Crohn's disease

#### Treatment start:

Treatment start can be given either by intravenous infusion or by subcutaneous administration:

- Intravenous infusion: The first dose of Tremfya is 200 mg, and it will be given by your doctor or nurse by intravenous infusion (drip in a vein in your arm). After the first dose, you will receive a second dose 4 weeks later and then a third dose after an additional 4 weeks.
- Subcutaneous administration: The first dose of Tremfya is 400 mg and will be given under the skin (subcutaneous injection) at different sites of the body. After the first dose, you will receive a second dose 4 weeks later and then a third dose after an additional 4 weeks.

#### Maintenance therapy:

A maintenance dose of Tremfya, 100 mg or 200 mg, will be given by injection under the skin (subcutaneous injection). Your doctor will determine which maintenance dose you will receive:

- A dose of 100 mg will be given 8 weeks after the third treatment start dose, and then every 8 weeks.
- A dose of 200 mg will be given 4 weeks after the third treatment start dose, and then every 4 weeks.

### **Do not exceed the recommended dose.**

You may decide together with your doctor that you are able to inject the medicine yourself. In this case, you will receive training on the right way to inject Tremfya. Talk to your doctor or nurse if you have any questions about self-injecting the medicine. It is important not to try to inject the medicine yourself until you have been trained by your doctor or nurse.

For detailed description of the instructions for use, carefully read the 'How to use' section below.

Adhere to the treatment as recommended by your doctor. Even if your health improves, do not stop the treatment with Tremfya without consulting your doctor.

### **If you have accidentally taken or received a higher dose or received the medicine earlier than prescribed by your doctor:**

Contact your doctor immediately.

If a child has accidentally swallowed some medicine, immediately see a doctor or go to a hospital emergency room and bring the medicine package with you.

### **If you forget to take the medicine**

If you have forgotten to inject a dose of Tremfya, inform your doctor.

### **If you stop using this medicine**

You should not stop using Tremfya without speaking to your doctor first. If you stop the treatment, your symptoms may come back.

### **Do not take medicines in the dark! Check the label and dose every time you take medicine. Wear glasses if you need them.**

**If you have any further questions about using this medicine, consult your doctor or pharmacist.**

#### **4. Side effects**

As with any medicine, using Tremfya may cause side effects in some users. Do not be alarmed by this list of side effects. You may not experience any of them.

##### **Serious side effects**

Tell your doctor or seek medical help immediately if any of the following side effects appears: **Serious allergic reactions** (may affect up to 1 in 100 users) – the signs or symptoms may include:

- difficulty breathing or swallowing
- swelling of the face, lips, tongue or throat
- severe itching of the skin, with a red rash or raised bumps
- lightheadedness, low blood pressure or dizziness

##### **Additional side effects**

The following side effects are mild to moderate. If any of these side effects becomes severe, tell your doctor, pharmacist or nurse immediately.

Very common side effects (effects that appear in more than one in ten users)

- respiratory tract infections

Common side effects (effects that appear in 1-10 in 100 users)

- headache
- joint pain (arthralgia)
- diarrhoea
- increased level of liver enzymes in the blood
- skin rash

Uncommon side effects (effects that appear in 1-10 in 1,000 users)

- decreased number of a type of white blood cell called neutrophils
- herpes simplex infections
- fungal infection of the skin, for instance between the toes (e.g., athlete's foot)
- stomach flu (gastroenteritis)
- urticaria (hives)
- redness, irritation or pain at the injection site

Rare side effects (effects that appear in 1-10 in 10,000 users)

- allergic reaction

**If you experience any side effect, if any side effect gets worse, or if you experience a side effect not mentioned in this leaflet, consult your doctor.**

##### **Reporting side effects**

You can report side effects to the Ministry of Health by following the 'Reporting Side Effects of Drug Treatment' link on the Ministry of Health home page ([www.health.gov.il](http://www.health.gov.il)), which opens an online form for reporting side effects, or you can also use this link:

<https://sideeffects.health.gov.il>

#### **5. How to store the medicine?**

- Prevent poisoning! To prevent poisoning, keep this and all other medicines in a closed

place, out of the reach and sight of children and/or infants. Do not induce vomiting unless explicitly instructed to do so by your doctor.

- Do not use the medicine after the expiry date (exp. date) which is stated on the package. The expiry date refers to the last day of that month.
- Store in a refrigerator at 2°C-8°C. Do not freeze.
- Keep the pre-filled syringe or pen in the outer carton in order to protect from light.
- Do not shake.
- Do not use this medicine if you notice that the solution is cloudy, discoloured or contains large particles.
- Before use, remove the carton from the refrigerator. Keep the pre-filled syringe or pen inside the carton until it reaches room temperature by waiting for 30 minutes.
- This medicine is intended for single use only.
- Do not throw away any medicine via wastewater or household waste. Ask the pharmacist how to dispose of medicines that are no longer needed. These measures will help protect the environment.

## **6. Additional information**

**In addition to the active ingredient, this medicine also contains:**

Sucrose, L-histidine monohydrochloride monohydrate, L-histidine, polysorbate 80, water for injection.

**What the medicine looks like and contents of the pack:**

A clear, colourless to light yellow solution. Each pack contains 1 pre-filled syringe or 1 pre-filled pen.

**Manufacturer's name and address:** Janssen-Cilag International NV, Belgium

**Registration holder's name and address:** J-C Health Care Ltd., Kibbutz Shefayim 6099000

**Registration number of the medicine in the Ministry of Health's National Drug Registry:**  
160-54-35346

Revised in September 2025

**How to use:**

Below are separate instructions for use of the pre-filled syringe, followed by separate instructions for the pre-filled pen.

**Instructions for use of the Tremfya 200 mg pre-filled syringe:**

**Single-use device**

**Important**

Tremfya is marketed as a pre-filled syringe that contains a 200 mg dose.

**Your doctor will tell you if you need one syringe or two.**

If your doctor decides that you or your caregiver are able to inject you with Tremfya at home, you should receive training by a healthcare professional on proper use, preparation and injection of Tremfya using the pre-filled syringe.

Please read these instructions for use of the pre-filled syringe before each injection. The instructions may be revised from time to time. This leaflet does not take the place of consulting with your doctor about your medical condition or your treatment. Read the Tremfya Patient Information Leaflet carefully before the injection. If you have any questions, contact your doctor or nurse.

Each pre-filled syringe is intended for single use. Dispose of the syringe (see step 4) after a single dose, even if medicine remains in it. Do not reuse the pre-filled syringe.

The Tremfya pre-filled syringe is intended for injection under the skin and not into the muscle or vein. After injection, the needle will retract into the body of the syringe and lock into place.

**Storage conditions**

Store in a refrigerator (2°C-8°C).

**Do not freeze. Do not shake.**

**Keep the pre-filled syringe in the original carton in order to protect from light and physical damage.**

**Keep Tremfya and all medicines out of the reach of children.**

**Parts of the pre-filled syringe**

**Before use**

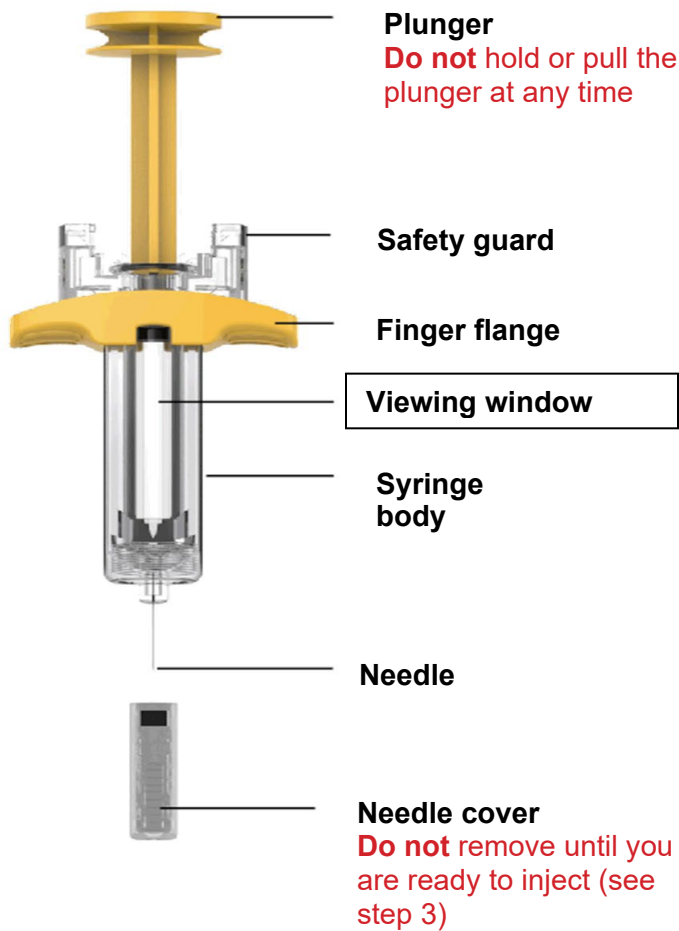

**After use**

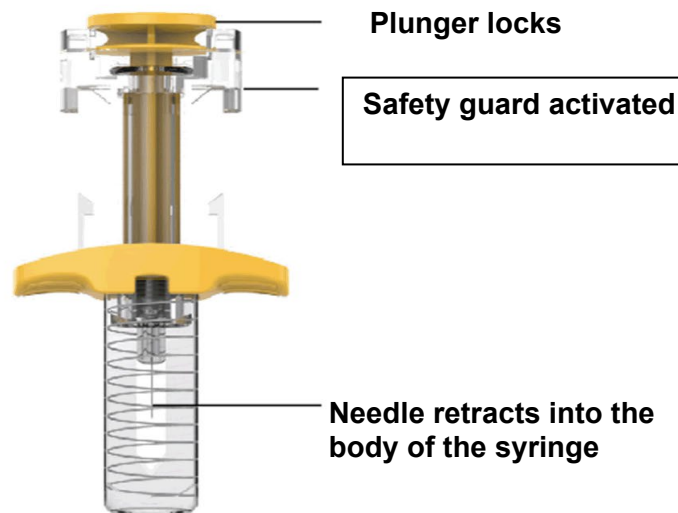

**For injection, you will need the following supplies:**

- 1 or 2 pre-filled syringes, depending on the dose your doctor prescribes.

**Supplies not included in the Tremfya syringe package:**

- Alcohol swabs
- Cotton balls or gauze pads
- Adhesive bandage
- Sharps container (see step 4).

**1. Prepare for your injection**

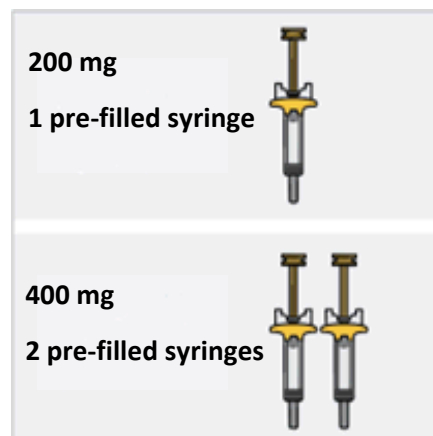

**Check the dose you were prescribed to know whether you will need one or two syringes and check the carton/s**

Remove the carton/s with the pre-filled syringe from the refrigerator.

**Check the expiry date ('EXP').**

If the expiry date has passed or if the seal on the carton is damaged, **do not** use the syringe. Contact your doctor or pharmacist to receive a new pre-filled syringe.

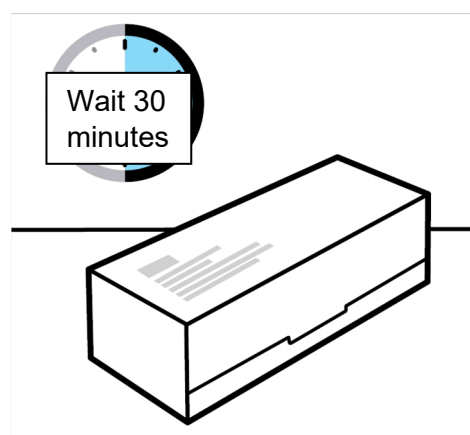

**Wait until Tremfya reaches room temperature**

Keep the pre-filled syringe/s in the carton/s. Place the carton/s on a flat surface at room temperature for approximately **30 minutes** before use.

**Do not** warm the pre-filled syringe any other way.

## 2. Prepare for your injection

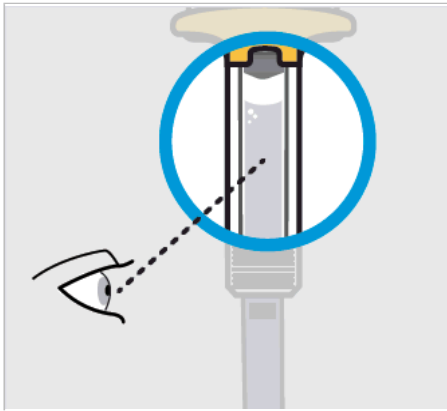

### **Check the liquid in the syringe to be sure that it is clear to slightly yellow**

Take the pre-filled syringe out of the carton.

Check the liquid in the syringe in the viewing window. Make sure that the liquid in the syringe is clear to slightly yellow. The liquid may contain tiny clear or white particles. You may also see air bubbles.

This is normal.

**Do not** use if the liquid is:

- Cloudy, or
- discoloured, or
- contains large particles

**Do not** use the syringe if it has been dropped.

If you are uncertain, contact your doctor or pharmacist to receive a new syringe.

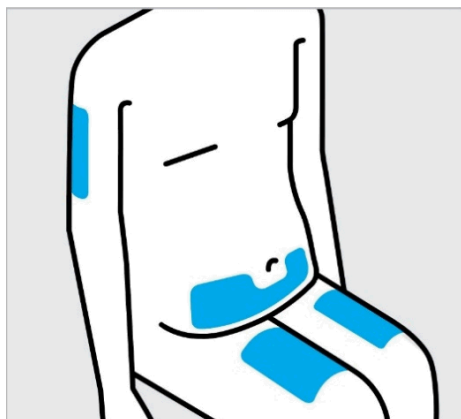

### **Choose the injection site**

Select one of the following areas for your injection:

- Front of the thigh
- Lower abdomen. **Do not** inject into the 5 cm area around your belly button
- Back of upper arm (only if a caregiver is giving you the injection)

**If you need to receive 2 syringes in order to complete the dose you were prescribed, choose two separate sites or leave at least 5 cm between the injection sites.**

**Do not** inject into skin that is tender, injured, red, scaly, thick or into areas with scars or stretch marks.

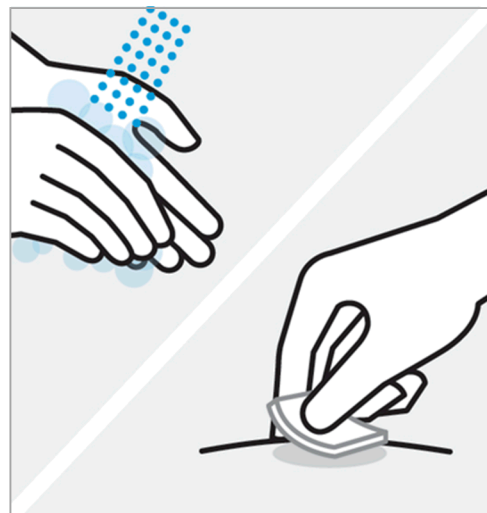

### **Wash your hands and clean the injection site**

Wash your hands well with soap and warm water.

Wipe the intended injection site with an alcohol swab and allow it to dry.

**Do not** touch, fan or blow on this area after you have cleaned it.

### **3. Inject Tremfya using the pre-filled syringe**

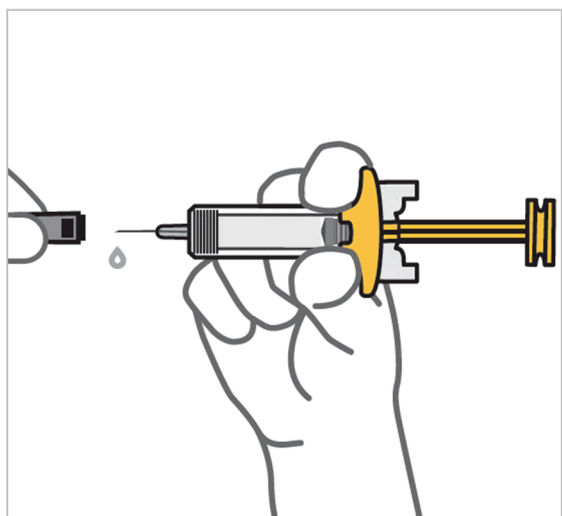

### **Remove needle cover at the bottom of the syringe when you are ready to inject**

Hold the pre-filled syringe by the body and pull needle cover off.

It is normal to see a few drops of liquid.

**Inject Tremfya within 5 minutes of removing the needle cover.**

**Do not** put needle cover back on, as this may damage the needle or lead to a needle stick injury.

**Do not** touch the needle or let it touch any surface.

**Do not** use the pre-filled syringe if it is dropped. In this case, contact your doctor or pharmacist to receive a new pre-filled syringe.

**Do not** hold or pull the plunger under any condition.

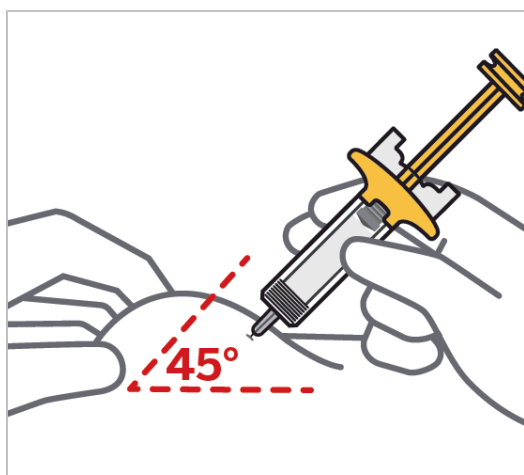

**Pinch the injection site and insert the needle at about a 45-degree angle**  
**It is important to pinch enough skin to inject under the skin and not into the muscle.**  
Insert needle with a quick, sharp motion (like a dart).

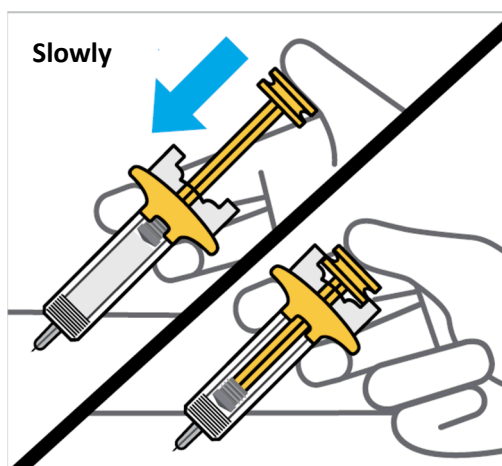

**Press the plunger slowly, all the way down until it stops so that all the liquid is injected**  
You may feel some resistance when you push the plunger. This is normal.



**Release pressure from the plunger to remove the needle from your skin**

The needle retracts into the device and will lock in place.

**If the doctor prescribed 2 syringes, repeat steps 2 and 3 with the second syringe.**

**4. After your injection**



**Check the injection site**

There may be a small amount of blood or liquid at the injection site. Place a cotton ball or gauze pad on the injection site and press down until the bleeding stops completely.

**Do not** rub the injection site. If needed, apply a bandage to the injection site.

Your injection is now complete!



**Throw the used syringe away**

Throw the used syringe into a sharps container right away after use.

Make sure that you empty the sharps container as instructed by your doctor or nurse when the container is full.

**Do not** dispose of your pre-filled syringe in your household waste.

**Do not** recycle the sharps container you used.



## **Instructions for use of the Tremfya 200 mg pre-filled pen:**

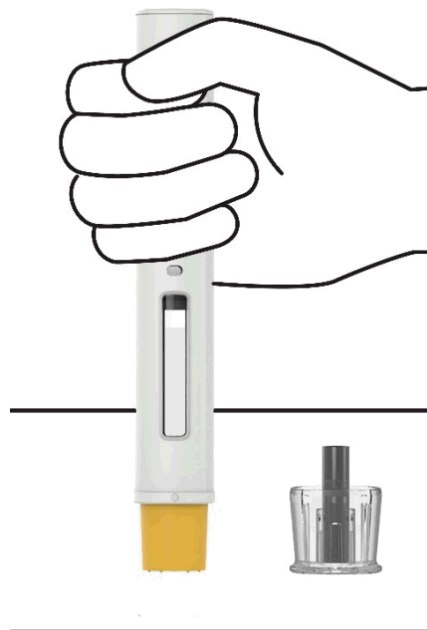

**Single-use device**

### **Important**

Tremfya is marketed as a pre-filled pen that contains a 200 mg dose.

**Your doctor will tell you if you need one pen or two.**

If your doctor decides that you or your caregiver are able to inject you with Tremfya at home, you should receive training by a healthcare professional on proper use, preparation and injection of Tremfya using the pre-filled pen.

Please read these instructions for use of the pre-filled pen before each injection. The instructions may be revised from time to time. This leaflet does not take the place of consulting with your doctor about your medical condition or your treatment. Read the Tremfya Patient Information Leaflet carefully before the injection. If you have any questions, contact your doctor or nurse.

Each pre-filled pen is intended for single use. Dispose of the pen (see step 4) after a single dose, even if medicine remains in it. Do not reuse the pre-filled pen.

### **Storage conditions**

Store in a refrigerator (2°C-8°C).

**Do not freeze. Do not shake.**

**Keep the pre-filled pen in the original carton in order to protect from light and physical damage.**

**Keep Tremfya and all medicines out of the reach of children.**

## Parts of the pre-filled syringe

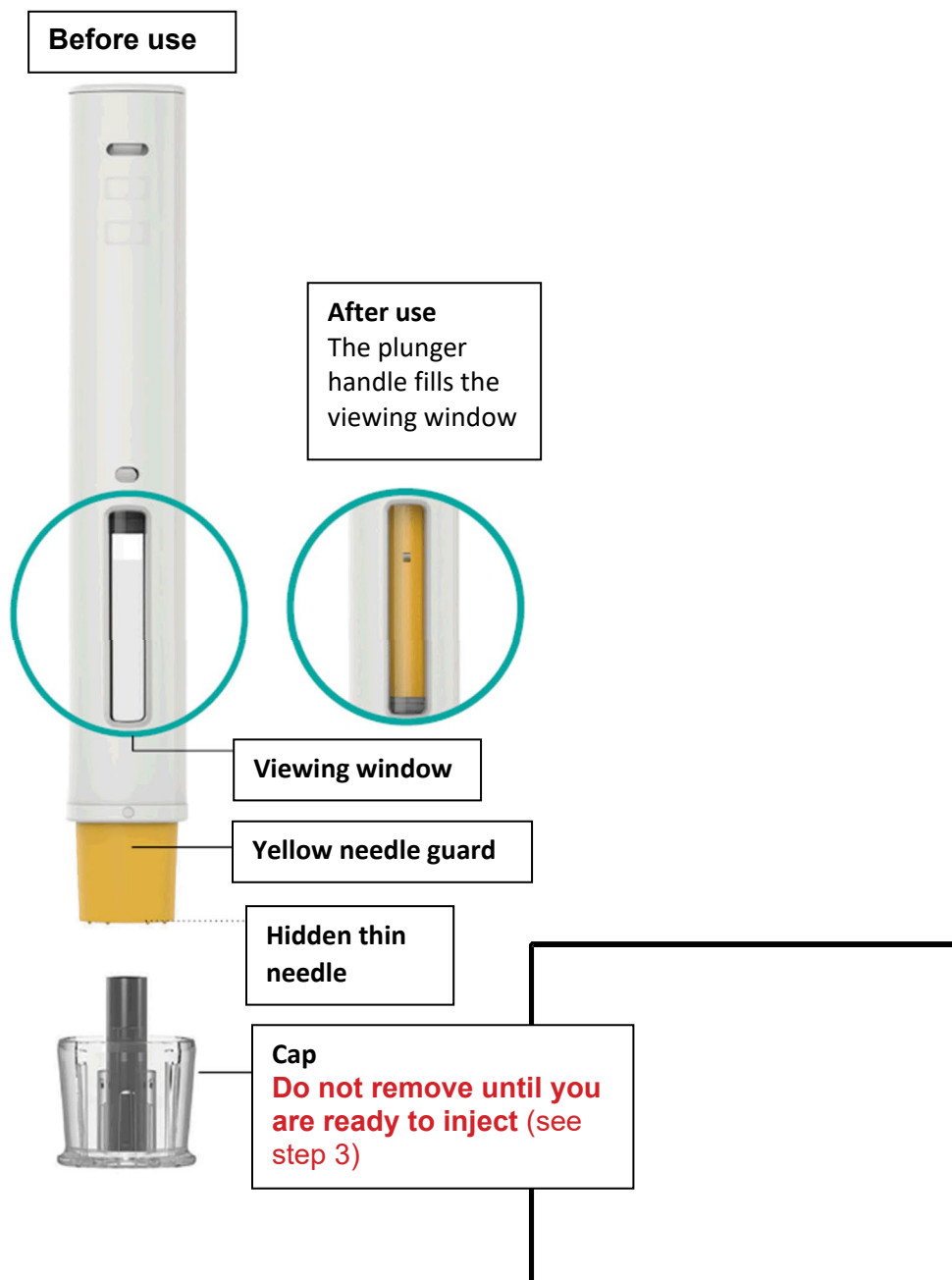

### For injection, you will need the following supplies:

- 1 or 2 pre-filled pens, depending on the dose your doctor prescribes.

### Supplies not included in the Tremfya pen package:

- Alcohol swabs
- Cotton balls or gauze pads
- Adhesive bandage
- Sharps container (see step 4).

## 1. Prepare for your injection

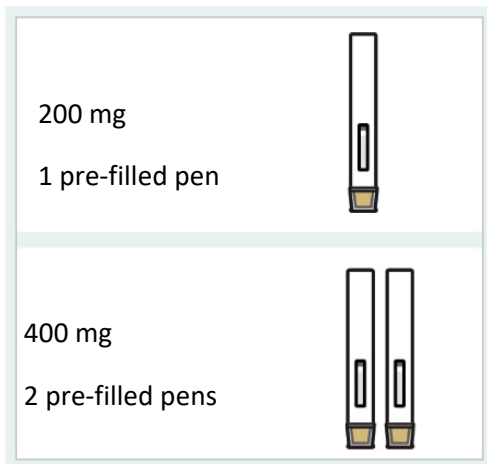

### **Check the dose you were prescribed to know whether you will need one or two pens and check the carton/s**

Remove the carton/s with the pre-filled pen from the refrigerator.

**Check the expiry date ('EXP')** on the carton.

If the expiry date has passed or if the seal on the carton is damaged, **do not** use the pen. Contact your doctor or pharmacist to obtain a new pen.

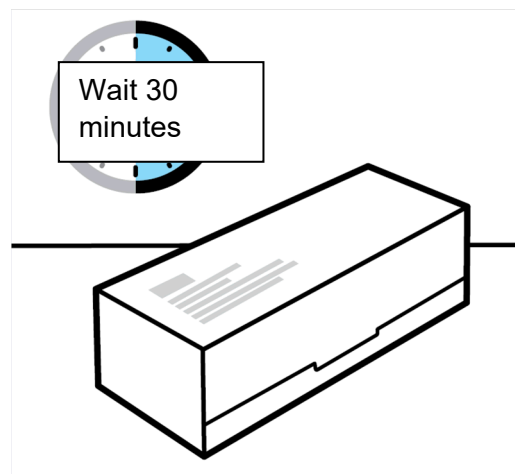

### **Allow Tremfya to come to room temperature**

Keep the pre-filled pen/s in the carton/s. Place the carton/s on a flat surface at room temperature for **approximately 30 minutes** before use.

**Do not** warm any other way.

## 2. Prepare for your injection

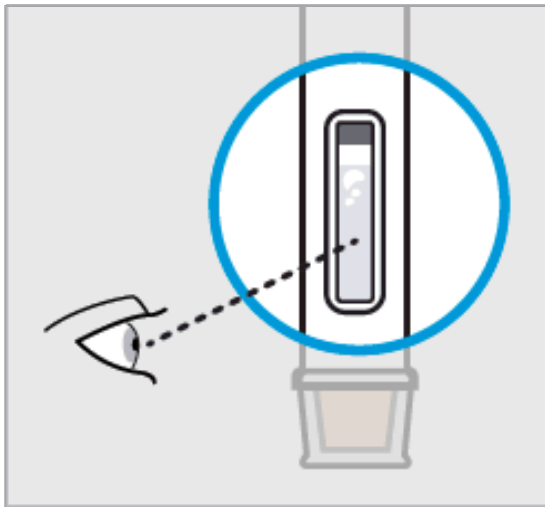

### **Check the liquid in the pen to be sure that it is clear to slightly yellow**

Take the pre-filled pen out of the carton.

Check the liquid in the pen in the viewing window. Make sure that the liquid in the pen is clear to slightly yellow. The liquid may contain tiny clear or white particles. You may also see air bubbles. This is normal.

**Do not** use if the liquid is:

- cloudy or
- discoloured, or
- contains large particles

If you are uncertain, contact your doctor or pharmacist to receive a new pen.



### **Choose the injection site**

Select one of the following areas for your injection:

- Front of the thigh
- Lower abdomen. Do not inject into the 5 cm area around your belly button
- Back of upper arm (only if a caregiver is giving you the injection)

**If you need to receive 2 pens in order to complete the dose you were prescribed, choose separate sites or leave at least 5 cm between the injection sites.**

**Do not** inject into skin that is tender, injured, red, scaly, thick or into areas with scars or stretch marks.

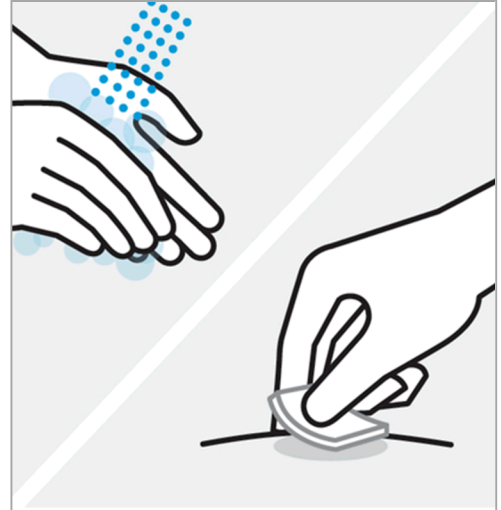

### **Wash your hands and clean the injection site**

Wash your hands well with soap and warm water.

Wipe the intended injection site with an alcohol swab and allow it to dry.

**Do not** touch, fan or blow on this area after you have cleaned it.

### **3. Inject Tremfya using the pre-filled pen**

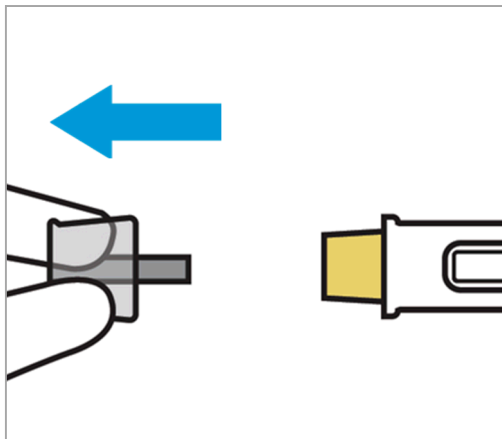

**Remove the cap when you are ready to inject**

**Do not touch the yellow needle guard!**

**It may start the injection, and you will not receive the dose.**

Pull the cap off. It is normal to see a few drops of liquid.

**Inject Tremfya within 5 minutes of removing the cap.**

**Do not** put the cap back on the needle, as this could damage the needle.

**Do not** use the pre-filled pen if it is dropped after removing the cap.

In this case, contact your doctor or pharmacist to receive a new pre-filled pen.

1st CLICK!

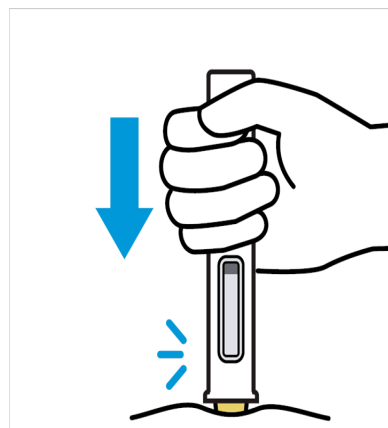

**Place the pre-filled pen directly on the injection site and then push and hold the pen**

**Do not lift the pre-filled pen during the injection!**

**If you do, the yellow needle guard will lock, and you will not get the full dose.**

Place the pen directly on the injection site with the yellow needle guard against the skin and the viewing window facing you.

Push on the pen and continue to hold it against the skin.

**You will hear the first click**

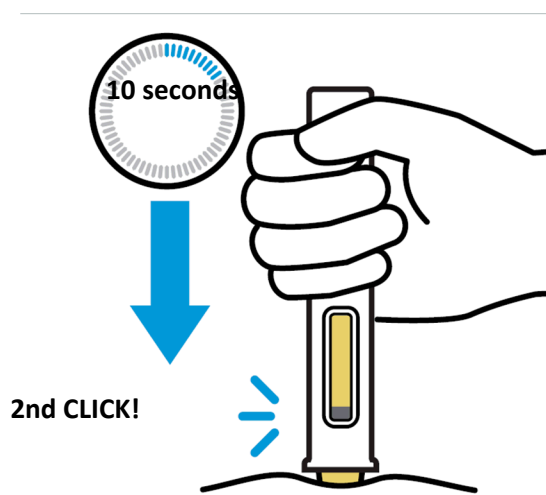

**Continue to hold the pen firmly against your skin for about 10 seconds until you hear the second click**

You are almost done.

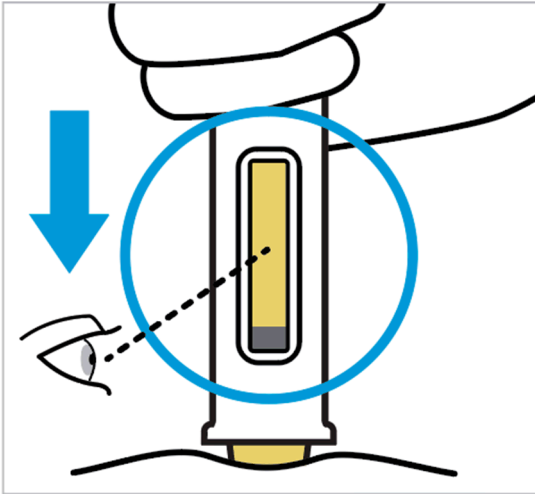

**Continue to hold the pen firmly against your skin and make sure that the injection is complete**

The injection is complete when the plunger handle stops and fills the viewing window.

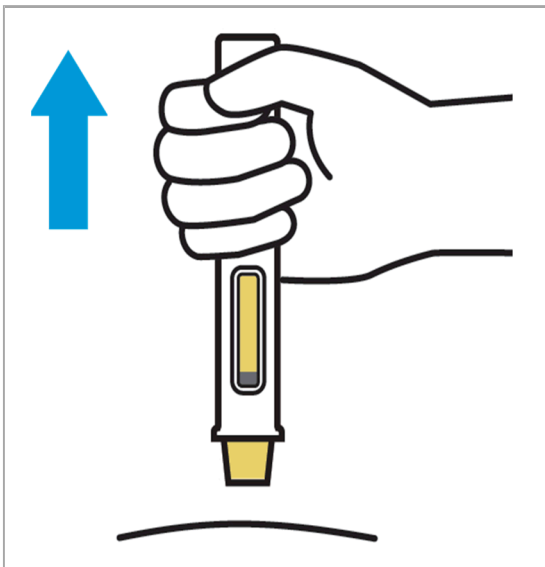

**Lift straight up**

**If the doctor prescribed 2 pens, repeat steps 2 and 3 with the second pen.**

#### 4. After your injection

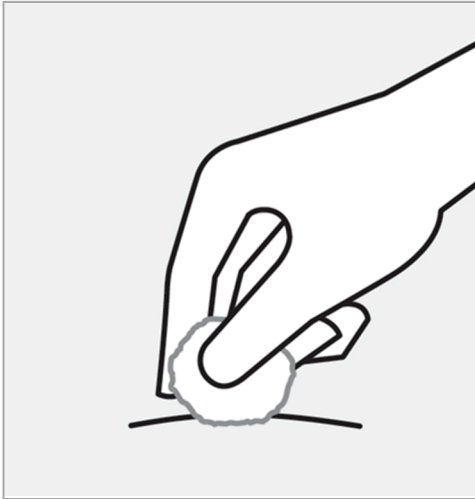

##### **Check the injection site**

There may be a small amount of blood or liquid at the injection site. Place a cotton ball or gauze pad on the injection site and press down until the bleeding stops completely.

**Do not** rub the injection site. If needed, apply a bandage to the injection site.

Your injection is now complete!



##### **Throw the used pen and the cap away**

Place the used pen in a sharps container right away after use.

Make sure that you empty the sharps container as instructed by your doctor or nurse when the container is full.

**Do not** dispose of your pre-filled pen in your household waste.

**Do not** recycle the sharps container you used.