

1. NAME OF THE MEDICINAL PRODUCT

Eylea 40 mg/ml solution for injection in a vial.

2. QUALITATIVE AND QUANTITATIVE COMPOSITION

1 ml solution for injection contains 40 mg aflibercept*.

Each vial contains 100 microlitres, equivalent to 4 mg aflibercept. This provides a usable amount to deliver a single dose of 50 microlitres containing 2 mg aflibercept.

*Fusion protein consisting of portions of human VEGF (Vascular Endothelial Growth Factor) receptors 1 and 2 extracellular domains fused to the Fc portion of human IgG1 and produced in Chinese hamster ovary (CHO) K1 cells by recombinant DNA technology.

For the full list of excipients, see section 6.1.

3. PHARMACEUTICAL FORM

Solution for intravitreal injection.

The solution is a clear, colourless to pale yellow and iso-osmotic solution.

Patient safety information guide

The marketing of Eylea is subject to a risk management plan (RMP) including a patient guide. The 'patient safety information guide', emphasizes important safety information that the patient should be aware of before and during treatment. Please explain to the patient the need to review the guide before starting treatment.

Prescriber guide and video

This product is marketed with prescriber guide and prescriber video providing recommendations for the risk minimization in the use of Eylea. Please ensure you are familiar with these materials as they contain important safety information.

4. CLINICAL PARTICULARS

4.1 Therapeutic indications

Eylea is indicated for adults for the treatment of

- neovascular (wet) age-related macular degeneration (AMD) (see section 5.1),
- visual impairment due to macular oedema secondary to retinal vein occlusion (branch RVO or central RVO) (see section 5.1),
- visual impairment due to diabetic macular oedema (DME) (see section 5.1),
- visual impairment due to myopic choroidal neovascularisation (myopic CNV) (see section 5.1).

4.2 Posology and method of administration

Eylea is for intravitreal injection only.

Eylea must only be administered by a qualified physician experienced in administering intravitreal injections.

Posology

wet AMD

The recommended dose for Eylea is 2 mg aflibercept, equivalent to 50 microlitres.

Eylea treatment is initiated with one injection per month for three consecutive doses. The treatment interval is then extended to two months.

Based on the physician's judgement of visual and/or anatomic outcomes, the treatment interval may be maintained at two months or further extended using a treat-and-extend dosing regimen, where injection intervals are increased in 2- or 4-weekly increments to maintain stable visual and/or anatomic outcomes. If visual and/or anatomic outcomes deteriorate, the treatment interval should be shortened accordingly to a minimum of two months during the first 12 months of treatment.

There is no requirement for monitoring between injections.

Based on the physician's judgement the schedule of monitoring visits may be more frequent than the injection visits.

Treatment intervals greater than four months between injections have not been studied (see Section 5.1).

Macular oedema secondary to RVO (branch RVO or central RVO)

The recommended dose for Eylea is 2 mg aflibercept equivalent to 50 microlitres. After the initial injection, treatment is given monthly. The interval between two doses should not be shorter than one month.

If visual and anatomic outcomes indicate that the patient is not benefiting from continued treatment, Eylea should be discontinued.

Monthly treatment continues until maximum visual acuity is achieved and/or there are no signs of disease activity. Three or more consecutive, monthly injections may be needed.

Treatment may then be continued with a treat-and-extend regimen with gradually increased treatment intervals to maintain stable visual and/or anatomic outcomes, however there are insufficient data to conclude on the length of these intervals. If visual and/or anatomic outcomes deteriorate, the treatment interval should be shortened accordingly.

The monitoring and treatment schedule should be determined by the treating physician based on the individual patient's response.

Monitoring for disease activity may include clinical examination, functional testing or imaging techniques (e.g. optical coherence tomography or fluorescein angiography).

Diabetic macular oedema

The recommended dose for Eylea is 2 mg aflibercept equivalent to 50 microlitres.

Eylea treatment is initiated with one injection per month for five consecutive doses, followed by one injection every two months. There is no requirement for monitoring between injections.

After the first 12 months of treatment with Eylea, and based on visual and/or anatomic outcomes, the treatment interval may be extended, such as with a treat-and-extend dosing regimen, where the treatment intervals are gradually increased to maintain stable visual and/or anatomic outcomes; however, there are insufficient data to conclude on the length of these intervals. If visual and/or anatomic outcomes deteriorate, the treatment interval should be shortened accordingly.

The schedule for monitoring should therefore be determined by the treating physician and may be more frequent than the schedule of injections.

If visual and anatomic outcomes indicate that the patient is not benefiting from continued treatment, Eylea should be discontinued.

Myopic choroidal neovascularisation

The recommended dose for Eylea is a single intravitreal injection of 2 mg aflibercept equivalent to 50 microlitres.

Additional doses may be administered if visual and/or anatomic outcomes indicate that the disease persists. Recurrences should be treated as a new manifestation of the disease.

The schedule for monitoring should be determined by the treating physician.

The interval between two doses should not be shorter than one month.

Special populations

Hepatic and/or renal impairment

No specific studies in patients with hepatic and/or renal impairment have been conducted with Eylea.

Available data do not suggest a need for a dose adjustment with Eylea in these patients (see section 5.2).

Elderly population

No special considerations are needed. There is limited experience in patients older than 75 years with DME.

Paediatric population

The safety and efficacy of Eylea have not been established in children and adolescents. There is no relevant use of Eylea in the paediatric population for the indications of wet AMD, CRVO, BRVO, DME and myopic CNV.

Method of administration

Intravitreal injections must be carried out according to medical standards and applicable guidelines by a qualified physician experienced in administering intravitreal injections. In general, adequate anaesthesia and asepsis, including topical broad spectrum microbicide (e.g. povidone iodine applied to the periocular skin, eyelid and ocular surface), have to be ensured. Surgical hand disinfection, sterile gloves, a sterile drape, and a sterile eyelid speculum (or equivalent) are recommended.

The injection needle should be inserted 3.5-4.0 mm posterior to the limbus into the vitreous cavity, avoiding the horizontal meridian and aiming towards the centre of the globe. The injection volume of 0.05 ml is then delivered; a different scleral site should be used for subsequent injections.

Immediately following the intravitreal injection, patients should be monitored for elevation in intraocular pressure. Appropriate monitoring may consist of a check for perfusion of the optic nerve head or tonometry. If required, sterile equipment for paracentesis should be available.

Following intravitreal injection patients should be instructed to report any symptoms suggestive of endophthalmitis (e.g. eye pain, redness of the eye, photophobia, blurring of vision) without delay.

Each vial should only be used for the treatment of a single eye. Extraction of multiple doses from a single vial may increase the risk of contamination and subsequent infection.

The vial contains more than the recommended dose of 2 mg aflibercept. The extractable volume of the vial (100 microlitres) is not to be used in total. The excess volume should be expelled before injecting.

Injecting the entire volume of the vial could result in overdose. To expel the air bubble along with excess medicinal product, slowly depress the plunger to align the cylindrical base of the dome plunger with the black dosing line on the syringe (equivalent to 50 microlitres i.e. 2 mg aflibercept).

After injection any unused product must be discarded.

For handling of the medicinal product before administration, see section 6.6.

4.3 Contraindications

Hypersensitivity to the active substance aflibercept or to any of the excipients listed in section 6.1.

Active or suspected ocular or periocular infection.

Active severe intraocular inflammation.

4.4 Special warnings and precautions for use

Intravitreal injection-related reactions

Intravitreal injections, including those with Eylea, have been associated with endophthalmitis, intraocular inflammation, rhegmatogenous retinal detachment, retinal tear and iatrogenic traumatic cataract (see section 4.8). Proper aseptic injection techniques must always be used when administering Eylea. In addition, patients should be monitored during the week following the injection to permit early treatment if an infection occurs. Patients should be instructed to report any symptoms suggestive of endophthalmitis or any of the above mentioned events without delay.

Increases in intraocular pressure have been seen within 60 minutes of intravitreal injection, including those with Eylea (see section 4.8). Special precaution is needed in patients with poorly controlled glaucoma (do not inject Eylea while the intraocular pressure is ≥ 30 mmHg). In all cases, both the intraocular pressure and the perfusion of the optic nerve head must therefore be monitored and managed appropriately.

Immunogenicity

As this is a therapeutic protein, there is a potential for immunogenicity with Eylea (see section 4.8). Patients should be instructed to report any signs or symptoms of intraocular inflammation, e.g. pain, photophobia, or redness, which may be a clinical sign attributable to hypersensitivity.

Systemic effects

Systemic adverse events including non-ocular haemorrhages and arterial thromboembolic events have been reported following intravitreal injection of VEGF inhibitors and there is a theoretical risk that these may relate to VEGF inhibition. There are limited data on safety in the treatment of patients with CRVO, BRVO, DME or myopic CNV with a history of stroke or transient ischaemic attacks or myocardial infarction within the last 6 months. Caution should be exercised when treating such patients.

Other

As with other intravitreal anti-VEGF treatments for AMD, CRVO, BRVO, DME and myopic CNV the following also applies:

- The safety and efficacy of Eylea therapy administered to both eyes concurrently have not been systematically studied (see section 5.1). If bilateral treatment is performed at the same time this could lead to an increased systemic exposure, which could increase the risk of systemic adverse events.
- Concomitant use of other anti-VEGF (vascular endothelial growth factor)
- There is no data available on the concomitant use of Eylea with other anti-VEGF medicinal products (systemic or ocular).
- Risk factors associated with the development of a retinal pigment epithelial tear after anti-VEGF therapy for wet AMD, include a large and/or high pigment epithelial retinal detachment. When initiating Eylea therapy, caution should be used in patients with these risk factors for retinal pigment epithelial tears.
- Treatment should be withheld in patients with rhegmatogenous retinal detachment or stage 3 or 4 macular holes.
- In the event of a retinal break the dose should be withheld and treatment should not be resumed until the break is adequately repaired.
- The dose should be withheld and treatment should not be resumed earlier than the next scheduled treatment in the event of:
 - a decrease in best-corrected visual acuity (BCVA) of ≥ 30 letters compared with the last assessment of visual acuity;
 - a subretinal haemorrhage involving the centre of the fovea, or, if the size of the haemorrhage is $\geq 50\%$, of the total lesion area.
- The dose should be withheld within the previous or next 28 days in the event of a performed or planned intraocular surgery.
- Eylea should not be used in pregnancy unless the potential benefit outweighs the potential risk to the foetus (see section 4.6).
- Women of childbearing potential have to use effective contraception during treatment and for at least 3 months after the last intravitreal injection of aflibercept (see section 4.6).
- There is limited experience with treatment of patients with ischaemic CRVO and BRVO. In patients presenting with clinical signs of irreversible ischaemic visual function loss, the treatment is not recommended.

Populations with limited data

There is only limited experience in the treatment of subjects with DME due to type I diabetes or in diabetic patients with an HbA1c over 12% or with proliferative diabetic retinopathy.

Eylea has not been studied in patients with active systemic infections or in patients with concurrent eye conditions such as retinal detachment or macular hole. There is also no experience of treatment with Eylea in diabetic patients with uncontrolled hypertension. This lack of information should be considered by the physician when treating such patients.

In myopic CNV there is no experience with Eylea in the treatment of non-Asian patients, patients who have previously undergone treatment for myopic CNV, and patients with extrafoveal lesions.

Information about excipients

This medicine contains less than 1 mmol sodium (23 mg) per dosage unit, that is to say essentially 'sodium-free'.

4.5 Interaction with other medicinal products and other forms of interaction

No interaction studies have been performed.

Adjunctive use of verteporfin photodynamic therapy (PDT) and Eylea has not been studied, therefore, a safety profile is not established.

4.6 Fertility, pregnancy and lactation

Women of childbearing potential

Women of childbearing potential have to use effective contraception during treatment and for at least 3 months after the last intravitreal injection of aflibercept (see section 4.4).

Pregnancy

There are no data on the use of aflibercept in pregnant women. Studies in animals have shown embryo-foetal toxicity (see section 5.3).

Although the systemic exposure after ocular administration is very low, Eylea should not be used during pregnancy unless the potential benefit outweighs the potential risk to the foetus.

Breast-feeding

It is unknown whether aflibercept is excreted in human milk. A risk to the breast-fed child cannot be excluded.

Eylea is not recommended during breast-feeding. A decision must be made whether to discontinue breast-feeding or to abstain from Eylea therapy taking into account the benefit of breast-feeding for the child and the benefit of therapy for the woman.

Fertility

Results from animal studies with high systemic exposure indicate that aflibercept can impair male and female fertility (see section 5.3). Such effects are not expected after ocular administration with very low systemic exposure.

4.7 Effects on ability to drive and use machines

Injection with Eylea has a minor influence on the ability to drive and use machines due to possible temporary visual disturbances associated either with the injection or the eye examination. Patients should not drive or use machines until their visual function has recovered sufficiently.

4.8 Undesirable effects

Summary of the safety profile

A total of 3,102 patients constituted the safety population in the eight phase III studies. Among those, 2,501 patients were treated with the recommended dose of 2 mg.

Serious ocular adverse reactions in the study eye related to the injection procedure have occurred in less than 1 in 1,900 intravitreal injections with Eylea and included blindness, endophthalmitis, retinal detachment, cataract traumatic, cataract, vitreous haemorrhage, vitreous detachment, and intraocular pressure increased (see section 4.4).

The most frequently observed adverse reactions (in at least 5% of patients treated with Eylea) were conjunctival haemorrhage (25%), retinal haemorrhage (11%), visual acuity reduced (11%), eye pain (10%), cataract (8%), intraocular pressure increased (8%), vitreous detachment (7%), and vitreous floaters (7%).

Tabulated list of adverse reactions

The safety data described below include all adverse reactions from the eight phase III studies in the indications wet AMD, CRVO, BRVO, DME and myopic CNV with a reasonable possibility of causality to the injection procedure or medicinal product.

The adverse reactions are listed by system organ class and frequency using the following convention:

Very common ($\geq 1/10$), common ($\geq 1/100$ to $< 1/10$), uncommon ($\geq 1/1,000$ to $< 1/100$), rare ($\geq 1/10,000$ to $< 1/1,000$)

Within each frequency grouping, adverse drug reactions are presented in order of decreasing seriousness.

Table 1: All treatment-emergent adverse drug reactions reported in patients in phase III studies (pooled data of the phase III studies for the indications wet AMD, CRVO, BRVO, DME and myopic CNV) or during post-marketing surveillance

System Organ Class	Very common	Common	Uncommon	Rare
Immune system disorders			Hypersensitivity***	
Eye disorders	Visual acuity reduced, Retinal haemorrhage Conjunctival haemorrhage, Eye pain	Retinal pigment epithelial tear*, Detachment of the retinal pigment epithelium, Retinal degeneration, Vitreous haemorrhage, Cataract, Cataract cortical, Cataract nuclear, Cataract subcapsular, Corneal erosion, Corneal abrasion, Intraocular pressure increased, Vision blurred, Vitreous floaters, Vitreous detachment, Injection site pain, Foreign body sensation in eyes, Lacrimation increased, Eyelid oedema, Injection site haemorrhage, Punctate keratitis, Conjunctival hyperaemia, Ocular hyperaemia	Endophthalmitis**, Retinal detachment, Retinal tear, Iritis, Uveitis, Iridocyclitis, Lenticular opacities, Corneal epithelium defect, Injection site irritation, Abnormal sensation in eye, Eyelid irritation, Anterior chamber flare, Corneal oedema	Blindness, Cataract traumatic, Vitritis, Hypopyon

* Conditions known to be associated with wet AMD. Observed in the wet AMD studies only.

** Culture positive and culture negative endophthalmitis

*** During the post-marketing period, reports of hypersensitivity included rash, pruritus, urticaria, and isolated cases of severe anaphylactic/anaphylactoid reactions

Description of selected adverse reactions

In the wet AMD phase III studies, there was an increased incidence of conjunctival haemorrhage in patients receiving anti-thrombotic agents. This increased incidence was comparable between patients treated with ranibizumab and Eylea.

Arterial thromboembolic events (ATEs) are adverse events potentially related to systemic VEGF inhibition. There is a theoretical risk of arterial thromboembolic events, including stroke and myocardial infarction, following intravitreal use of VEGF inhibitors.

A low incidence rate of arterial thromboembolic events was observed in the Eylea clinical trials in patients with AMD, DME, RVO and myopic CNV. Across indications no notable difference between the groups treated with aflibercept and the respective comparator groups were observed.

As with all therapeutic proteins, there is a potential for immunogenicity with Eylea.

Reporting of suspected adverse reactions

Reporting suspected adverse reactions after authorisation of the medicinal product is important. It allows continued monitoring of the benefit/risk balance of the medicinal product.

Any suspected adverse events should be reported to the Ministry of Health according to the National Regulation by using an online form

<https://sideeffects.health.gov.il/>

4.9 Overdose

In clinical trials, doses of up to 4 mg in monthly intervals have been used and isolated cases of overdoses with 8 mg occurred.

Overdosing with increased injection volume may increase intraocular pressure. Therefore, in case of overdose, intraocular pressure should be monitored and if deemed necessary by the treating physician, adequate treatment should be initiated.

5. PHARMACOLOGICAL PROPERTIES

5.1 Pharmacodynamic properties

Pharmacotherapeutic group: Ophthalmologicals / Antineovascularisation agents
ATC code: S01LA05

Aflibercept is a recombinant fusion protein consisting of portions of human VEGF receptor 1 and 2 extracellular domains fused to the Fc portion of human IgG1.

Aflibercept is produced in Chinese hamster ovary (CHO) K1 cells by recombinant DNA technology.

Aflibercept acts as a soluble decoy receptor that binds VEGF-A and PlGF with higher affinity than their natural receptors, and thereby can inhibit the binding and activation of these cognate VEGF receptors.

Mechanism of action

Vascular endothelial growth factor-A (VEGF-A) and placental growth factor (PlGF) are members of the VEGF family of angiogenic factors that can act as potent mitogenic, chemotactic, and vascular permeability factors for endothelial cells. VEGF acts via two receptor tyrosine kinases; VEGFR-1 and VEGFR-2, present on the surface of endothelial cells. PlGF binds only to VEGFR-1, which is also present on the surface of leucocytes. Excessive activation of these receptors by VEGF-A can result in pathological neovascularisation and excessive vascular permeability. PlGF can synergize with VEGF-A in these processes, and is also known to promote leucocyte infiltration and vascular inflammation.

Pharmacodynamic effects

wet AMD

Wet AMD is characterised by pathological choroidal neovascularisation (CNV). Leakage of blood and fluid from CNV may cause retinal thickening or oedema and/or sub-/intra-retinal haemorrhage, resulting in loss of visual acuity.

In patients treated with Eylea (one injection per month for three consecutive months, followed by one injection every 2 months), central retinal thickness [CRT] decreased soon after treatment initiation, and the mean CNV lesion size was reduced, consistent with the results seen with ranibizumab 0.5 mg every month.

In the VIEW1 study there were mean decreases in CRT on optical coherence tomography (OCT) (-130 and -129 microns at week 52 for the Eylea 2 mg every two months and ranibizumab 0.5 mg every month study groups, respectively). Also at the 52 week time point, in the VIEW2 study there were mean decreases in CRT on OCT (-149 and -139 microns for the Eylea 2 mg every two months and ranibizumab 0.5 mg every month study groups, respectively).

The reduction of CNV size and reduction in CRT were generally maintained in the second year of the studies.

The ALTAIR study was conducted in Japanese patients with treatment naïve wet AMD, showing similar outcomes to the VIEW studies using 3 initial monthly Eylea 2 mg injections, followed by one injection after a further 2 months, and then continued with a treat-and-extend regimen with variable treatment intervals (2-week or 4-week adjustments) up to a maximum 16 week interval according to pre-specified criteria. At week 52, there were mean decreases in central retinal thickness (CRT) on OCT of -134.4 and -126.1 microns for the 2-week adjustment group and the 4-week adjustment group, respectively. The proportion of patients without fluid on OCT at week 52 was 68.3% and 69.1% in the 2- and 4-week adjustment groups, respectively. The reduction in CRT was generally maintained in both treatment arms in the second year of the ALTAIR study.

Macular oedema secondary to CRVO and BRVO

In CRVO and BRVO, retinal ischaemia occurs and signals the release of VEGF which in turn destabilises the tight junctions, and promotes endothelial cell proliferation. Up-regulation of VEGF is associated with the breakdown of the blood retina barrier, increased vascular permeability, retinal oedema, and neovascularisation complications.

In patients treated with 6 consecutive monthly injections of Eylea 2mg, there was a consistent, rapid and robust morphologic response (as measured by improvements in mean CRT) observed. At week 24, the reduction in CRT was statistically superior versus control in all three studies (COPERNICUS in CRVO: -457 vs. -145 microns; GALILEO in CRVO: -449 vs. -169 microns; VIBRANT in BRVO: -280 vs. -128 microns).

This decrease from baseline in CRT was maintained to the end of each study, week 100 in COPERNICUS, week 76 in GALILEO, and week 52 in VIBRANT.

Diabetic macular oedema

Diabetic macular oedema is a consequence of diabetic retinopathy and is characterised by increased vasopermeability and damage to the retinal capillaries which may result in loss of visual acuity.

In patients treated with Eylea, the majority of whom were classified as having Type II diabetes, a rapid and robust response in morphology (CRT, DRSS level) was observed.

In the VIVID^{DME} and the VISTA^{DME} studies, a statistically significant greater mean decrease in CRT from baseline to week 52 was observed in patients treated with Eylea than with the laser control, -192.4 and -183.1 microns for the 2Q8 Eylea groups and -66.2 and -73.3 microns for the control groups, respectively. At week 100 the decrease was maintained with -195.8 and -191.1 microns for the 2Q8 Eylea groups and -85.7 and -83.9 microns for the control groups, in the VIVID^{DME} and VISTA^{DME} studies, respectively.

A ≥ 2 step improvement in DRSS was assessed in a pre-specified manner in VIVID^{DME} and VISTA^{DME}. The DRSS score was gradable in 73.7% of the patients in VIVID^{DME} and 98.3% of the patients in VISTA^{DME}. At week 52, 27.7% and 29.1% of the Eylea 2Q8 groups, and 7.5% and 14.3% of the control groups experienced a ≥ 2 step improvement in the DRSS. At week 100, the respective percentages were 32.6% and 37.1% of the Eylea 2Q8 groups and 8.2% and 15.6% of the control groups.

Myopic choroidal neovascularisation

Myopic choroidal neovascularisation (myopic CNV) is a frequent cause of vision loss in adults with pathologic myopia. It develops as a wound healing mechanism consequent to Bruch's membrane ruptures and represents the most vision-threatening event in pathologic myopia.

In patients treated with Eylea in the MYRROR study (one injection given at start of therapy, with additional injections given in case of disease persistence or recurrence), CRT decreased soon after treatment initiation favouring Eylea at week 24 (-79 microns and -4 microns for the Eylea 2 mg treatment group and the control group, respectively), which was maintained through week 48. In addition, the mean CNV lesion size decreased.

Clinical efficacy and safety

wet AMD

The safety and efficacy of Eylea were assessed in two randomised, multi-centre, double-masked, active-controlled studies in patients with wet AMD (VIEW1 and VIEW2) with a total of 2,412 patients treated and evaluable for efficacy (1,817 with Eylea). Patient ages ranged from 49 to 99 years with a mean of 76 years. In these clinical studies, approximately 89% (1,616/1,817) of the patients randomised to treatment with Eylea were 65 years of age or older, and approximately 63% (1,139/1,817) were 75 years of age or older. In each study, patients were randomly assigned in a 1:1:1:1 ratio to 1 of 4 dosing regimens:

- 1) Eylea administered at 2 mg every 8 weeks following 3 initial monthly doses (Eylea 2Q8);
- 2) Eylea administered at 2 mg every 4 weeks (Eylea 2Q4);
- 3) Eylea administered at 0.5 mg every 4 weeks (Eylea 0.5Q4); and
- 4) ranibizumab administered at 0.5 mg every 4 weeks (ranibizumab 0.5Q4).

In the second year of the studies, patients continued to receive the initially randomised dosage but on a modified dosing schedule guided by assessment of visual and anatomic outcomes with a protocol-defined maximum dosing interval of 12 weeks.

In both studies, the primary efficacy endpoint was the proportion of patients in the Per Protocol Set who maintained vision, i.e. losing fewer than 15 letters of visual acuity at week 52 from baseline.

In the VIEW1 study, at week 52, 95.1% of patients in the Eylea 2Q8 group maintained vision compared to 94.4% patients in the ranibizumab 0.5Q4 group.

In the VIEW2 study, at week 52, 95.6% of patients in the Eylea 2Q8 group maintained vision compared to 94.4% patients in the ranibizumab 0.5Q4 group. In both studies Eylea was shown to be non-inferior and clinically equivalent to the ranibizumab 0.5Q4 group.

Detailed results from the combined analysis of both studies are shown in Table 2 and Figure 1 below.

Table 2: Efficacy outcomes at week 52 (primary analysis) and week 96; combined data from the VIEW1 and VIEW2 studies^{B)}

Efficacy Outcome	Eylea 2Q8 ^{E)} (Eylea 2 mg every 8 weeks following 3 initial monthly doses) (N = 607)		Ranibizumab 0.5Q4 (ranibizumab 0.5 mg every 4 weeks) (N = 595)	
	Week 52	Week 96	Week 52	Week 96
Mean number of injections from baseline	7.6	11.2	12.3	16.5
Mean number of injections from Week 52 to 96		4.2		4.7
Proportion of patients with < 15 letters loss from baseline (PPS ^{A)})	95.33% ^{B)}	92.42%	94.42% ^{B)}	91.60%
Difference ^{C)} (95% CI) ^{D)}	0.9% (-1.7, 3.5) ^{F)}	0.8% (-2.3, 3.8) ^{F)}		
Mean change in BCVA as measured by ETDRS ^{A)} letter score from baseline	8.40	7.62	8.74	7.89
Difference in LS ^{A)} mean change (ETDRS letters) ^{C)} (95% CI) ^{D)}	-0.32 (-1.87, 1.23)	-0.25 (-1.98, 1.49)		
Proportion of patients with ≥ 15 letters gain from baseline	30.97%	33.44%	32.44%	31.60%
Difference ^{C)} (95% CI) ^{D)}	-1.5% (-6.8, 3.8)	1.8% (-3.5, 7.1)		

A) BCVA: Best Corrected Visual Acuity
 ETDRS: Early Treatment Diabetic Retinopathy Study
 LS: Least square means derived from ANCOVA
 PPS: Per Protocol Set

B) Full Analysis Set (FAS), Last Observation Carried Forward (LOCF) for all analyses except proportion of patients with maintained visual acuity at week 52 which is PPS

C) The difference is the value of the Eylea group minus the value of the ranibizumab group. A positive value favours Eylea.

D) Confidence interval (CI) calculated by normal approximation

E) After treatment initiation with three monthly doses

F) A confidence interval lying entirely above -10% indicates a non-inferiority of Eylea to ranibizumab

Figure 1. Mean Change in Visual Acuity from Baseline to Week 96 for the Combined Data from the View1 and View2 Studies

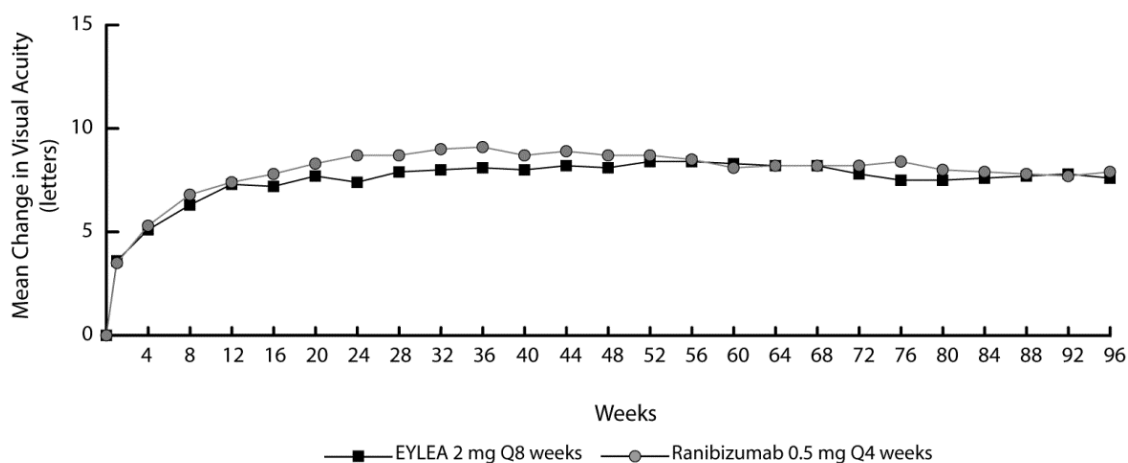

In combined data analysis of VIEW1 and VIEW2, Eylea demonstrated clinically meaningful changes from baseline in pre-specified secondary efficacy endpoint National Eye Institute Visual Function Questionnaire (NEI VFQ-25) without clinically meaningful differences to ranibizumab. The magnitude of these changes was similar to that seen in published studies, which corresponded to a 15-letter gain in Best Corrected Visual Acuity (BCVA).

In the second year of the studies, efficacy was generally maintained through the last assessment at week 96, and 2-4% of patients required all injections on a monthly basis, and a third of patients required at least one injection with a treatment interval of only one month.

Decreases in mean CNV area were evident in all dose groups in both studies.

Efficacy results in all evaluable subgroups (e.g. age, gender, race, baseline visual acuity, lesion type, lesion size) in each study and in the combined analysis were consistent with the results in the overall populations.

ALTAIR was a 96 week multicentre, randomised, open-label study in 247 Japanese patients with treatment naïve wet AMD, designed to assess the efficacy and safety of Eylea following two different adjustment intervals (2-weeks and 4-weeks) of a treat-and-extend dosing regimen.

All patients received monthly doses of Eylea 2 mg for 3 months, followed by one injection after a further 2 month interval. At week 16, patients were randomised 1:1 into two treatment groups: 1) Eylea treat-and-extend with 2-week adjustments and 2) Eylea treat-and-extend with 4-week adjustments. Extension or shortening of the treatment interval was decided based on visual and/or anatomic criteria defined by protocol with a maximum treatment interval of 16 weeks for both groups.

The primary efficacy endpoint was mean change in BCVA from baseline to week 52. The secondary efficacy endpoints were the proportion of patients who did not lose ≥ 15 letters and the proportion of patients who gained at least 15 letters of BCVA from baseline to week 52.

At week 52, patients in the treat-and-extend arm with 2-week adjustments gained a mean of 9.0 letters from baseline as compared to 8.4 letters for those in the 4-week adjustment group [LS mean difference in letters (95% CI): -0.4 (-3.8,3.0), ANCOVA]. The proportion of patients who did not lose ≥ 15 letters in the two treatment arms was similar (96.7% in the 2-week and 95.9% in the 4-week adjustment groups). The proportion of patients who gained ≥ 15 letters at week 52 was 32.5% in the 2-week adjustment group and 30.9% in the 4-week adjustment group. The proportion of patients who extended their treatment interval to 12 weeks or beyond was 42.3% in the 2-week adjustment group and 49.6% in the 4-week adjustment group. Furthermore, in the 4-week adjustment group 40.7% of patients were extended to 16-week intervals. At the last visit up to week 52, 56.8% and 57.8% of patients in the 2-week and 4-week adjustment groups, respectively had their next injection scheduled at an interval of 12 weeks or beyond.

In the second year of the study, efficacy was generally maintained up to and including the last assessment at week 96, with a mean gain from baseline of 7.6 letters for the 2-week adjustment group and 6.1 letters for the 4-week adjustment group. The proportion of patients who extended their treatment interval to 12 weeks or beyond was 56.9% in the 2-week adjustment group and 60.2% in the 4-week adjustment group. At the last visit prior to week 96, 64.9% and 61.2% of patients in the 2-week and 4-week adjustment groups, respectively had their next injection scheduled at an interval of 12 weeks or beyond. During the second year of treatment patients in both the 2-week and 4-week adjustment groups received an average of 3.6 and 3.7 injections, respectively. Over the 2 year treatment period patients received an average of 10.4 injections

Ocular and systemic safety profiles were similar to the safety observed in the pivotal studies VIEW1 and VIEW2.

Macular oedema secondary to CRVO

The safety and efficacy of Eylea were assessed in two randomised, multi-centre, double-masked, sham-controlled studies in patients with macular oedema secondary to CRVO (COPERNICUS and GALILEO) with a total of 358 patients treated and evaluable for efficacy (217 with Eylea). Patient ages ranged from 22 to 89 years with a mean of 64 years. In the CRVO studies, approximately 52% (112/217) of the patients randomised to treatment with Eylea were 65 years of age or older, and approximately 18% (38/217) were 75 years of age or older. In both studies, patients were randomly assigned in a 3:2 ratio to either 2 mg Eylea administered every 4 weeks (2Q4), or the control group receiving sham injections every 4 weeks for a total of 6 injections

After 6 consecutive monthly injections, patients received treatment only if they met pre-specified retreatment criteria, except for patients in the control group in the GALILEO study who continued to receive sham (control to control) until week 52. From this timepoint all patients were treated if pre-specified criteria were met.

In both studies, the primary efficacy endpoint was the proportion of patients who gained at least 15 letters in BCVA at week 24 compared to baseline. A secondary efficacy variable was change in visual acuity at week 24 compared to baseline.

The difference between treatment groups was statistically significant in favour of Eylea in both studies. The maximal improvement in visual acuity was achieved at month 3 with subsequent stabilisation of visual acuity and CRT until month 6. The statistically significant difference was maintained through week 52.

Detailed results from the analysis of both studies are shown in Table 3 and Figure 2 below.

Table 3: Efficacy outcomes at week 24, week 52 and week 76/100 (Full Analysis Set with LOCF^C) in COPERNICUS and GALILEO studies

Efficacy Outcomes	COPERNICUS						GALILEO					
	24 Weeks		52 Weeks		100 Weeks		24 Weeks		52 Weeks		76 Weeks	
	Eylea 2 mg Q4 (N = 114)	Control (N= 73)	Eylea 2 mg (N = 114)	Control ^{E)} (N =73)	Eylea ^{F)} 2 mg (N= 114)	Control ^{E,F)} (N=73)	Eylea 2 mg Q4 (N = 103)	Control (N = 68)	Eylea 2 mg (N = 103)	Control (N = 68)	Eylea ^{G)} 2 mg (N = 103)	Control ^{G)} (N = 68)
Proportion of patients with ≥ 15 letters gain from baseline	56%	12%	55%	30%	49.1%	23.3%	60%	22%	60%	32%	57.3%	29.4%
Weighted difference ^{A,B,E)} (95% CI) p-value	44.8% (33.0, 56.6) p < 0.0001		25.9% (11.8, 40.1) p = 0.0006		26.7% (13.1, 40.3) p=0.0003		38.3% (24.4, 52.1) p < 0.0001		27.9% (13.0, 42.7) p = 0.0004		28.0% (13.3, 42.6) p=0.0004	
Mean change in BCVA ^{C)} as measured by ETDRS ^{C)} letter score from baseline (SD)	17.3 (12.8)	-4.0 (18.0)	16.2 (17.4)	3.8 (17.1)	13.0 (17.7)	1.5 (17.7)	18.0 (12.2)	3.3 (14.1)	16.9 (14.8)	3.8 (18.1)	13.7 (17.8)	6.2 (17.7)
Difference in LS mean ^{A,C,D,E)} (95% CI) p-value	21.7 (17.4, 26.0) p < 0.0001		12.7 (7.7, 17.7) p < 0.0001		11.8 (6.7, 17.0) p < 0.0001		14.7 (10.8, 18.7) p < 0.0001		13.2 (8.2, 18.2) p < 0.0001		7.6 (2.1, 13.1) p=0.0070	

A) Difference is Eylea 2 mg Q4 weeks minus control

B) Difference and confidence interval (CI) are calculated using Cochran-Mantel-Haenszel (CMH) test adjusted for region (America vs. rest of the world for COPERNICUS and Europe vs. Asia/Pacific for GALILEO) and baseline BCVA category (> 20/200 and \leq 20/200)

C) BCVA: Best Corrected Visual Acuity

ETDRS: Early Treatment Diabetic Retinopathy Study

LOCF: Last Observation Carried Forward

SD: Standard deviation

LS: Least square means derived from ANCOVA

D) LS mean difference and confidence interval based on an ANCOVA model with factors treatment group, region (America vs. rest of the world for COPERNICUS and Europe vs. Asia/Pacific for GALILEO) and baseline BCVA category (> 20/200 and \leq 20/200)

E) In COPERNICUS study, control group patients could receive Eylea on an as-needed basis as frequently as every 4 weeks during week 24 to week 52; patients had visits every 4 weeks.

F) In COPERNICUS study, both control group and Eylea 2mg patients received Eylea 2 mg on an as-needed basis as frequently as every 4 weeks starting from week 52 to week 96; patients had mandatory quarterly visits but may have been seen as frequently as every 4 weeks if necessary.

G) In GALILEO study, both control group and Eylea 2mg patients received Eylea 2 mg on an as-needed basis every 8 weeks starting from week 52 to week 68; patients had mandatory visits every 8 weeks.

Figure 2: Mean Change from Baseline to Week 76/100 in Visual Acuity by Treatment Group for the COPERNICUS and GALILEO Studies (Full Analysis Set)

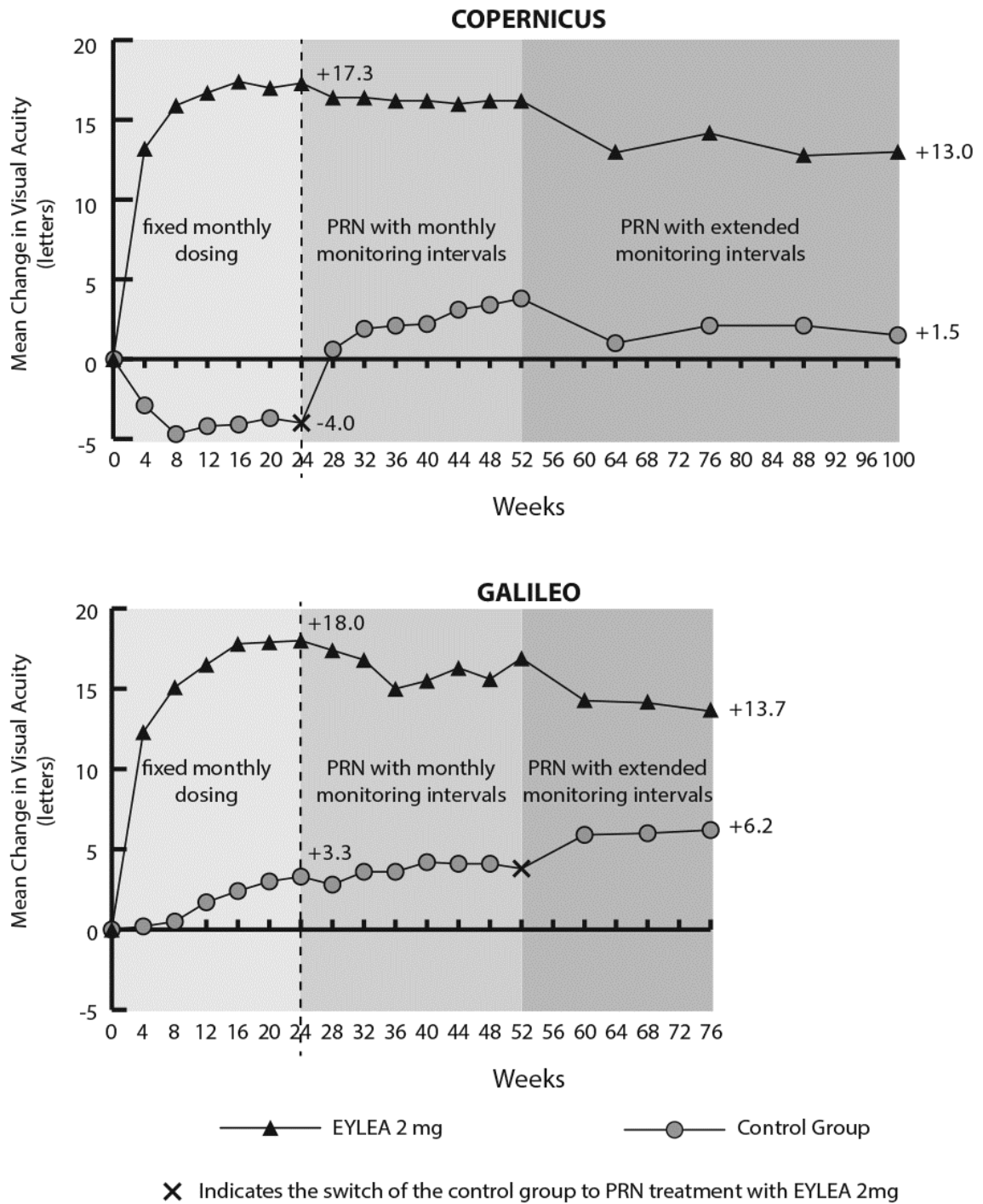

In GALILEO, 86.4% (n=89) of the Eylea group and 79.4% (n=54) of the sham group had perfused CRVO at baseline. At week 24, this was 91.8% (n=89) in the Eylea group and 85.5% (n=47) in the sham group. These proportions were maintained at week 76, with 84.3% (n=75) in the Eylea group and 84.0% (n=42) in the sham group.

In COPERNICUS, 67.5% (n = 77) of the Eylea group and 68.5% (n = 50) of the sham group had perfused CRVO at baseline. At week 24, this was 87.4% (n = 90) in the Eylea group and 58.6% (n = 34) in the sham group. These proportions were maintained at week 100 with 76.8 % (n = 76) in the Eylea group and 78% (n = 39) in the sham group. Patients in the sham group were eligible to receive Eylea from week 24.

The beneficial effect of Eylea treatment on visual function was similar in the baseline subgroups of perfused and non-perfused patients. Treatment effects in other evaluable subgroups (e.g. age, gender, race, baseline visual acuity, CRVO duration) in each study were in general consistent with the results in the overall populations.

In combined data analysis of GALILEO and COPERNICUS, Eylea demonstrated clinically meaningful changes from baseline in pre-specified secondary efficacy endpoint National Eye Institute Visual Function Questionnaire (NEI VFQ-25). The magnitude of these changes was similar to that seen in published studies, which corresponded to a 15-letter gain in Best Corrected Visual Acuity (BCVA).

Macular oedema secondary to BRVO

The safety and efficacy of Eylea were assessed in a randomised, multi-centre, double-masked, active-controlled study in patients with macular oedema secondary to BRVO (VIBRANT) which included Hemi-Retinal Vein Occlusion. A total of 181 patients were treated and evaluable for efficacy (91 with Eylea). Patient ages ranged from 42 to 94 years with a mean of 65 years. In the BRVO study, approximately 58% (53/91) of the patients randomised to treatment with Eylea were 65 years of age or older, and approximately 23% (21/91) were 75 years of age or older. In the study, patients were randomly assigned in a 1:1 ratio to either 2 mg Eylea administered every 8 weeks following 6 initial monthly injections or laser photocoagulation administered at baseline (laser control group). Patients in the laser control group could receive additional laser photocoagulation (called 'rescue laser treatment') beginning at week 12 with a minimum interval of 12 weeks. Based on pre-specified criteria, patients in the laser group could receive rescue treatment with Eylea 2mg from week 24, administered every 4 weeks for 3 months followed by every 8 weeks.

In the VIBRANT study, the primary efficacy endpoint was the proportion of patients who gained at least 15 letters in BCVA at week 24 compared to baseline and the Eylea group was superior to laser control.

A secondary efficacy endpoint was change in visual acuity at week 24 compared to baseline, which was statistically significant in favour of Eylea in the VIBRANT study. The course of visual improvement was rapid and peaked at 3 months with maintenance of the effect until month 12.

In the laser group 67 patients received rescue treatment with Eylea beginning at week 24 (Active Control/ Eylea 2mg group), which resulted in improvement of visual acuity by about 5 letters from week 24 to 52.

Detailed results from the analysis of the VIBRANT study are shown in Table 4 and Figure 3 below.

Table 4: Efficacy outcomes at week 24 and week 52 (Full Analysis Set with LOCF) in VIBRANT study

Efficacy Outcomes	VIBRANT			
	24 Weeks		52 Weeks	
	Eylea 2mg Q4 (N = 91)	Active Control (laser) (N = 90)	Eylea 2mg Q8 (N = 91) ^{D)}	Active Control (laser)/Eylea 2mg ^{E)} (N = 90)
Proportion of patients with ≥15 letters gain from Baseline (%)	52.7%	26.7%	57.1%	41.1%
Weighted Difference ^{A,B)} (%) (95% CI) p-value	26.6% (13.0, 40.1) p=0.0003		16.2% (2.0, 30.5) p=0.0296	
Mean change in BCVA as measured by ETDRS letter score from Baseline (SD)	17.0 (11.9)	6.9 (12.9)	17.1 (13.1)	12.2 (11.9)
Difference in LS mean ^{A,C)} (95% CI) p-value	10.5 (7.1, 14.0) p<0.0001		5.2 (1.7, 8.7) p=0.0035 ^{F)}	

A) Difference is Eylea 2 mg Q4 weeks minus Laser Control

B) Difference and 95% CI are calculated using Mantel-Haenszel weighting scheme adjusted for region (North America vs. Japan) and baseline BCVA category (> 20/200 and ≤ 20/200)

C) LS mean difference and 95% CI based on an ANCOVA model with treatment group, baseline BCVA category (> 20/200 and ≤ 20/200) and region (North America vs. Japan) as fixed effects, and baseline BCVA as covariate.

D) From week 24 on the treatment interval in the Eylea treatment group was extended for all subjects from 4 weeks to 8 weeks through week 48.

E) Beginning at week 24 subjects in the Laser Group could receive rescue treatment with Eylea, if they met at least one pre-specified eligibility criterion. At total of 67 subjects in this group received Eylea rescue treatment. The fixed regimen for Eylea rescue was three times Eylea 2mg every 4 weeks followed by injections every 8 weeks.

F) Nominal p-value

Figure 3: Mean Change in BCVA as Measured by ETDRS Letter Score from Baseline to Week 52 in VIBRANT Study

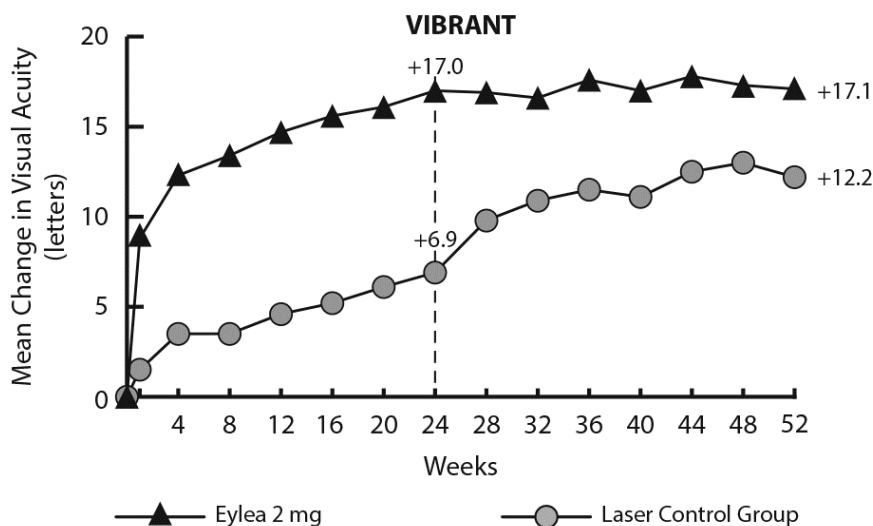

At baseline, the proportion of perfused patients in the Eylea and laser groups was 60% and 68%, respectively. At week 24 these proportions were 80% and 67%, respectively. In the Eylea group the proportion of perfused patients was maintained through week 52. In the laser group, where patients were eligible for rescue treatment with Eylea from week 24, the proportion of perfused patients increased to 78% by week 52.

Diabetic macular oedema

The safety and efficacy of Eylea were assessed in two randomised, multi-centre, double-masked, active-controlled studies in patients with DME (VIVID^{DME} and VISTA^{DME}). A total of 862 patients were treated and evaluable for efficacy, 576 with Eylea. Patient ages ranged from 23 to 87 years with a mean of 63 years. In the DME studies, approximately 47% (268/576) of the patients randomised to treatment with Eylea were 65 years of age or older, and approximately 9% (52/576) were 75 years of age or older. The majority of patients in both studies had Type II diabetes.

In both studies, patients were randomly assigned in a 1:1:1 ratio to 1 of 3 dosing regimens:

- 1) Eylea administered 2 mg every 8 weeks following 5 initial monthly injections (Eylea 2Q8);
- 2) Eylea administered 2 mg every 4 weeks (Eylea 2Q4); and
- 3) macular laser photocoagulation (active control).

Beginning at week 24, patients meeting a pre-specified threshold of vision loss were eligible to receive additional treatment: patients in the Eylea groups could receive laser and patients in the control group could receive Eylea.

In both studies, the primary efficacy endpoint was the mean change from baseline in BCVA at week 52 and both Eylea 2Q8 and Eylea 2Q4 groups demonstrated statistical significance and were superior to the control group. This benefit was maintained through week 100.

Detailed results from the analysis of the VIVID^{DME} and VISTA^{DME} studies are shown in Table 5 and Figure 4 below.

Table 5: Efficacy **outcomes** at week 52 and week 100 (Full Analysis Set with LOCF) in VIVID^{DME} and VISTA^{DME} studies

Efficacy Outcomes	VIVID ^{DME}						VISTA ^{DME}					
	52 Weeks			<u>100 Weeks</u>			52 Weeks			<u>100 Weeks</u>		
	Eylea 2 mg Q8 ^A (N = 135)	Eylea 2 mg Q4 (N = 136)	Active Control (laser) (N = 132)	Eylea 2 mg Q8 ^A (N = 135)	Eylea 2 mg Q4 (N = 136)	Active Control (laser) (N = 132)	Eylea 2 mg Q8 ^A (N = 151)	Eylea 2 mg Q4 (N = 154)	Active Control (laser) (N = 154)	Eylea 2 mg Q8 ^A (N = 151)	Eylea 2 mg Q4 (N = 154)	Active Control (laser) (N = 154)
Mean change in BCVA as measured by ETDRS ^E letter score from Baseline	10.7	10.5	1.2	9.4	11.4	0.7	10.7	12.5	0.2	11.1	11.5	0.9
Difference in LS mean ^{B,C,E} (97.5% CI)	9.1 (6.3, 11.8)	9.3 (6.5, 12.0)		8.2 (5.2, 11.3)	10.7 (7.6, 13.8)		10.45 (7.7, 13.2)	12.19 (9.4, 15.0)		10.1 (7.0, 13.3)	10.6 (7.1, 14.2)	

Efficacy Outcomes	VIVID ^{DME}						VISTA ^{DME}					
	52 Weeks			<u>100 Weeks</u>			52 Weeks			<u>100 Weeks</u>		
	Eylea 2 mg Q8 ^A (N = 135)	Eylea 2 mg Q4 (N = 136)	Active Control (laser) (N = 132)	Eylea 2 mg Q8 ^A (N = 135)	Eylea 2 mg Q4 (N = 136)	Active Control (laser) (N = 132)	Eylea 2 mg Q8 ^A (N = 151)	Eylea 2 mg Q4 (N = 154)	Active Control (laser) (N = 154)	Eylea 2 mg Q8 ^A (N = 151)	Eylea 2 mg Q4 (N = 154)	Active Control (laser) (N = 154)
Proportion of patients with ≥ 15 letters gain from Baseline	33%	32%	9%	31.1%	38.2%	12.1%	31%	42%	8%	33.1%	38.3%	13.0%
Adjusted Difference ^{D,C,E} (97.5% CI)	24% (13.5, 34.9)	23% (12.6, 33.9)		19.0% (8.0, 29.9)	26.1% (14.8, 37.5)		23% (13.5, 33.1)	34% (24.1, 44.4)		20.1% (9.6, 30.6)	25.8% (15.1, 36.6)	

- A After treatment initiation with 5 monthly injections
- B LS mean and CI based on an ANCOVA model with baseline BCVA measurement as a covariate and a factor for treatment group. Additionally, region (Europe/Australia vs. Japan) had been included as factor for VIVID^{DME}, and history of MI and/or CVA as a factor for VISTA^{DME}.
- C Difference is Eylea group minus active control (laser) group
- D Difference with confidence interval (CI) and statistical test is calculated using Mantel-Haenszel weighting scheme adjusted by region (Europe/Australia vs. Japan) for VIVID^{DME} and medical history of MI or CVA for VISTA^{DME}
- E BCVA: Best Corrected Visual Acuity
 ETDRS: Early Treatment Diabetic Retinopathy Study
 LOCF: Last Observation Carried Forward
 LS: Least square means derived from ANCOVA
 CI: Confidence interval

Figure 4: Mean Change in BCVA as Measured by ETDRS Letter Score from Baseline to Week 100 in VIVID^{DME} and VISTA^{DME} Studies

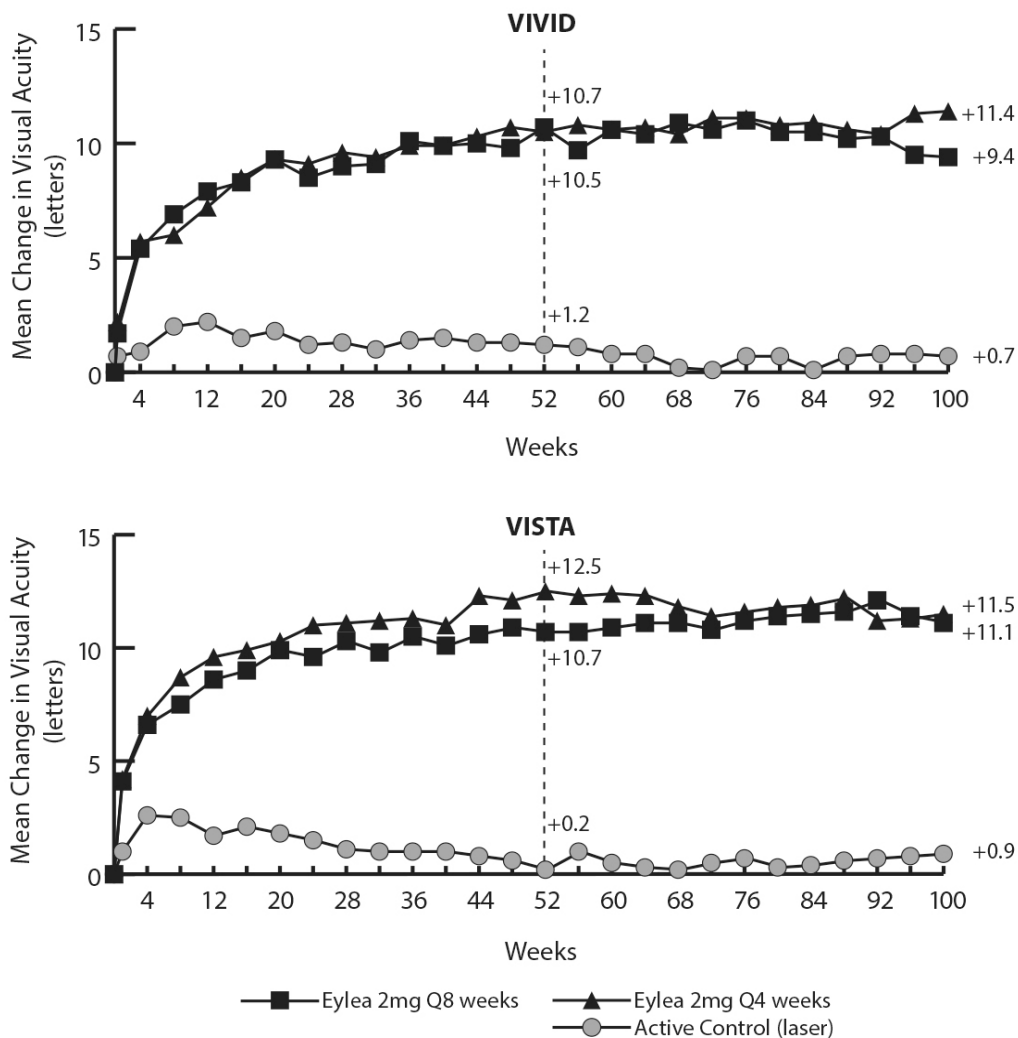

Treatment effects in evaluable subgroups (e.g., age, gender, race, baseline HbA1c, baseline visual acuity, prior anti-VEGF therapy) in each study and in the combined analysis were generally consistent with the results in the overall populations.

In the VIVID^{DME} and VISTA^{DME} studies, 36 (9%) and 197 (43%) patients received prior anti-VEGF therapy, respectively, with a 3-month or longer washout period. Treatment effects in the subgroup of patients who had previously been treated with a VEGF inhibitor were similar to those seen in patients who were VEGF inhibitor naïve.

Patients with bilateral disease were eligible to receive anti-VEGF treatment in their fellow eye if assessed necessary by the physician. In the VISTA^{DME} study, 217 (70.7%) of Eylea patients received bilateral Eylea injections until week100; in the VIVID^{DME} study, 97 (35.8 %) of Eylea patients received a different anti-VEGF treatment in their fellow eye.

An independent comparative trial (DRCR.net Protocol T) utilised a dosing regimen based on strict OCT and vision re-treatment criteria. In the aflibercept treatment group (n = 224) at week 52, this treatment regimen resulted in patients receiving a mean of 9.2 injections, which is similar to the administered number of doses in the Eylea 2Q8 group in VIVID^{DME} and VISTA^{DME}, while overall efficacy of the aflibercept treatment group in Protocol T was comparable to the Eylea 2Q8 group in VIVID^{DME} and VISTA^{DME}. A 13.3 mean letter gain with 42% of patients gaining at least 15 letters in vision from baseline was observed in Protocol T. Ocular and systemic safety profiles (including ATEs) were similar to VIVID^{DME} and VISTA^{DME}.

Myopic choroidal neovascularisation

The safety and efficacy of Eylea were assessed in a randomised, multi-centre, double-masked, sham-controlled study in treatment-naïve, Asian patients with myopic CNV. A total of 121 patients were treated and evaluable for efficacy (90 with Eylea). Patient ages ranged from 27 to 83 years with a mean of 58 years. In the myopic CNV study, approximately 36% (33/91) of the patients randomised to treatment with Eylea were 65 years of age or older, and approximately 10% (9/91) were 75 years of age or older.

Patients were randomly assigned in a 3:1 ratio to receive either 2 mg Eylea intravitreally or sham injections administered once at study start with additional injections given monthly in case of disease persistence or recurrence until week 24, when the primary endpoint was assessed. At week 24, patients initially randomised to sham were eligible to receive the first dose of Eylea. Following this, patients in both groups continued to be eligible for additional injections in case of disease persistence or recurrence.

The difference between treatment groups was statistically significant in favour of Eylea for the primary endpoint (change in BCVA) and confirmatory secondary efficacy endpoint (proportion of patients who gained 15 letters in BCVA) at week 24 compared to baseline. Differences for both endpoints were maintained through week 48.

Detailed results from the analysis of the MYRROR study are shown in Table 6 and Figure 5 below.

Table 6: Efficacy outcomes at week 24 (primary analysis) and week 48 in MYRROR study (Full Analysis Set with LOCF^{A)})

Efficacy Outcomes	MYRROR			
	24 Weeks		48 Weeks	
	Eylea 2mg (N = 90)	Sham (N = 31)	Eylea 2mg (N = 90)	Sham/ Eylea 2mg (N = 31)
Mean change in BCVA ^{B)} as measured by ETDRS letter score from baseline (SD) ^{B)}	12.1 (8.3)	-2.0 (9.7)	13.5 (8.8)	3.9 (14.3)
Difference in LS mean ^{C,D,E)} (95% CI)	14.1 (10.8, 17.4)		9.5 (5.4, 13.7)	
Proportion of patients with \geq 15 letters gain from baseline	38.9%	9.7%	50.0%	29.0%
Weighted difference ^{D,F)} (95% CI)	29.2% (14.4, 44.0)		21.0% (1.9, 40.1)	

- A) LOCF: Last Observation Carried Forward
- B) BCVA: Best Corrected Visual Acuity
ETDRS: Early Treatment Diabetic Retinopathy Study
SD: Standard Deviation
- C) LS mean: Least square means derived from ANCOVA model
- D) CI: Confidence Interval
- E) LS mean difference and 95% CI based on an ANCOVA model with treatment group and country (country designations) as fixed effects, and baseline BCVA as covariant.
- F) Difference and 95% CI are calculated using Cochran-Mantel-Haenszel (CMH) test adjusted for country (country designations)

Figure 5: Mean Change from Baseline to Week 48 in Visual Acuity by Treatment Group for the MYRROR Study (Full Analysis Set, LOCF)

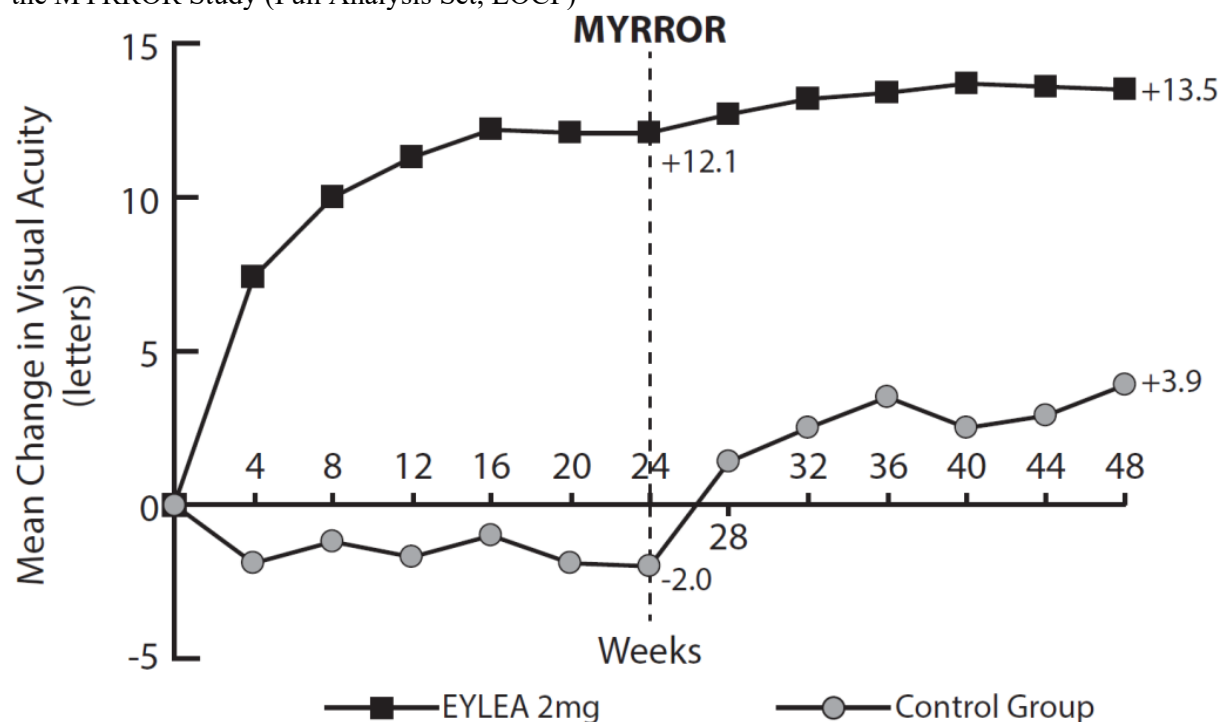

5.2 Pharmacokinetic properties

Eylea is administered directly into the vitreous to exert local effects in the eye.

Absorption / Distribution

Aflibercept is slowly absorbed from the eye into the systemic circulation after intravitreal administration and is predominately observed in the systemic circulation as an inactive, stable complex with VEGF; however only “free aflibercept” is able to bind endogenous VEGF.

In a pharmacokinetic sub-study in 6 neovascular wet AMD patients with frequent sampling, maximum plasma concentrations of free aflibercept (systemic C_{max}) were low, with a mean of approximately 0.02 microgram/ml (range 0 to 0.054) within 1 to 3 days after a 2 mg intravitreal injection, and were undetectable two weeks following dosage in almost all patients. Aflibercept does not accumulate in the plasma when administered intravitreally every 4 weeks.

The mean maximum plasma concentration of free aflibercept is approximately 50 to 500 times below the aflibercept concentration required to inhibit the biologic activity of systemic VEGF by 50% in animal models, in which blood pressure changes were observed after circulating levels of free aflibercept attained approximately 10 microgram/ml and returned to baseline when levels fell below approximately 1 microgram/ml. It is estimated that after intravitreal administration of 2 mg to patients, the mean maximum plasma concentration of free aflibercept is more than 100-fold lower than the concentration of aflibercept required to half-maximally bind systemic VEGF (2.91 microgram/ml) in a study of healthy volunteers. Therefore, systemic pharmacodynamic effects such as blood pressure changes are unlikely.

In pharmacokinetic sub-studies in patients with CRVO, BRVO, DME or myopic CNV mean C_{max} of free aflibercept in plasma were similar with values in the range of 0.03 to 0.05 microgram/ml and individual values not exceeding 0.14 microgram/ml. Thereafter, plasma concentrations of free aflibercept declined to values below or close to the lower limit of quantitation generally within one week; undetectable concentrations were reached before the next administration after 4 weeks in all patients.

Elimination

As Eylea is a protein-based therapeutic, no metabolism studies have been conducted.

Free aflibercept binds VEGF to form a stable, inert complex. As with other large proteins, both free and bound aflibercept are expected to be cleared by proteolytic catabolism.

Renal impairment

No special studies in patients with renal impairment have been conducted with Eylea.

Pharmacokinetic analysis of patients in the VIEW2 study, of which 40% had renal impairment (24% mild, 15% moderate, and 1% severe), revealed no differences with respect to plasma concentrations of active drug after intravitreal administration every 4 or 8 weeks.

Similar results were seen in patients with CRVO in the GALILEO study, in patients with DME in the VIVID^{DME} study, and in patients with myopic CNV in the MYRROR study.

5.3 Preclinical safety data

Effects in non-clinical studies on repeated dose toxicity were observed only at systemic exposures considered substantially in excess of the maximum human exposure after intravitreal administration at the intended clinical dose indicating little relevance to clinical use.

Erosions and ulcerations of the respiratory epithelium in nasal turbinates in monkeys treated with aflibercept intravitreally were observed at systemic exposures in excess of the maximum human exposure. The systemic exposure based on C_{max} and AUC for free aflibercept were approximately 200- and 700-fold higher, respectively, when compared to corresponding values observed in humans after an intravitreal dose of 2 mg. At the No Observed Adverse Effect Level (NOAEL) of 0.5 mg/eye in monkeys the systemic exposure was 42- and 56-fold higher based on C_{max} and AUC, respectively.

No studies have been conducted on the mutagenic or carcinogenic potential of aflibercept.

An effect of aflibercept on intrauterine development was shown in embryo-foetal development studies in pregnant rabbits with intravenous (3 to 60 mg/kg) as well as subcutaneous (0.1 to 1 mg/kg) administration. The maternal NOAEL was at the dose of 3 mg/kg or 1 mg/kg, respectively. A developmental NOAEL was not identified. At the 0.1 mg/kg dose, the systemic exposures based on C_{max} and cumulative AUC for free aflibercept were approximately 17- and 10-fold higher, respectively, when compared to corresponding values observed in humans after an intravitreal dose of 2 mg.

Effects on male and female fertility were assessed as part of a 6-month study in monkeys with intravenous administration of aflibercept at doses ranging from 3 to 30 mg/kg. Absent or irregular menses associated with alterations in female reproductive hormone levels and changes in sperm morphology and motility were observed at all dose levels. Based on C_{max} and AUC for free aflibercept observed at the 3 mg/kg intravenous dose, the systemic exposures were approximately 4,900-fold and 1,500-fold higher, respectively, than the exposure observed in humans after an intravitreal dose of 2 mg. All changes were reversible.

6. PHARMACEUTICAL PARTICULARS

6.1 List of excipients

Sucrose
Sodium chloride
Sodium phosphate monobasic monohydrate
Sodium phosphate dibasic heptahydrate
Polysorbate 20
Water for injection

6.2 Incompatibilities

In the absence of compatibility studies, this medicinal product must not be mixed with other medicinal products.

6.3 Shelf life

The expiry date of the product is indicated on the packaging materials.

6.4 Special precautions for storage

Store in a refrigerator (2°C to 8°C).
Do not freeze.
Keep the vial in the outer carton in order to protect from light.

Prior to usage, the unopened vial of Eylea may be stored at room temperature (below 25°C) for up to 24 hours.

6.5 Nature and contents of container

100 microlitres of solution in a 2ml vial (type I glass) with a stopper (fluoropolymer rubber), and an 18 G filter needle. Pack size of 1 Vial + 1 filter needle. After opening the vial, proceed under aseptic conditions.

6.6 Special precautions for disposal and other handling

The vial is for single use in one eye only.

Since the vial contains more volume (100 microlitres) than the recommended dose (50 microlitres), a part of the volume contained in the vial has to be discarded prior to the administration.

The solution should be inspected visually for any foreign particulate matter and/or discolouration or any variation in physical appearance prior to administration. In the event of either being observed, discard the medicinal product.

Filter needle:

BD Blunt Filter (Fill) Needle, not for skin injection.

Do not autoclave the BD Blunt Filter (Fill) Needle.

The filter needle is non-pyrogenic. Do not use it if individual packaging is damaged.

Discard the used BD Blunt Filter (Fill) Needle in approved sharps collector.

Caution: Re-use of the filter needle may lead to infection or other illness/injury.

For the intravitreal injection, a 30 G x ½ inch injection needle should be used.

Instructions for use of vial:

1. Remove the plastic cap and disinfect the outer part of the rubber stopper of the vial.

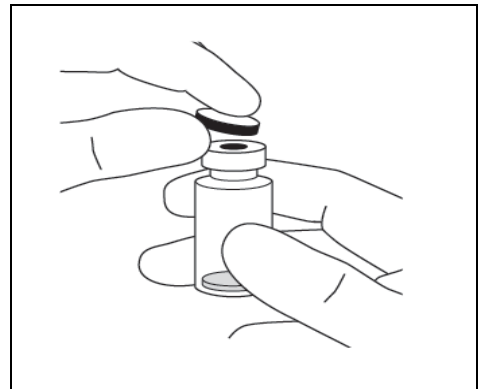

2. Attach the 18 G, 5-micron filter needle supplied in the carton to a 1-ml sterile, Luer-lock syringe.

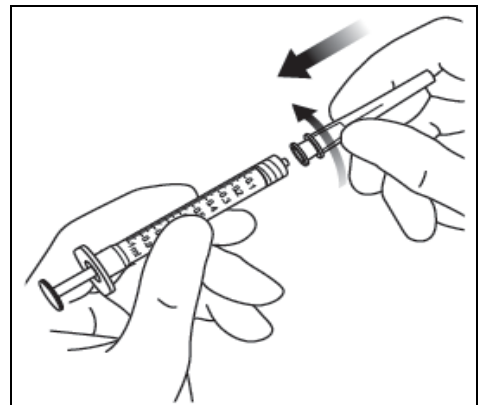

3. Push the filter needle into the centre of the vial stopper until the needle is completely inserted into the vial and the tip touches the bottom or bottom edge of the vial.
4. Using aseptic technique withdraw all of the Eylea vial contents into the syringe, keeping the vial in an upright position, slightly inclined to ease complete withdrawal. To deter the introduction of air, ensure the bevel of the filter needle is submerged into the liquid. Continue to tilt the vial during withdrawal keeping the bevel of the filter needle submerged in the liquid.

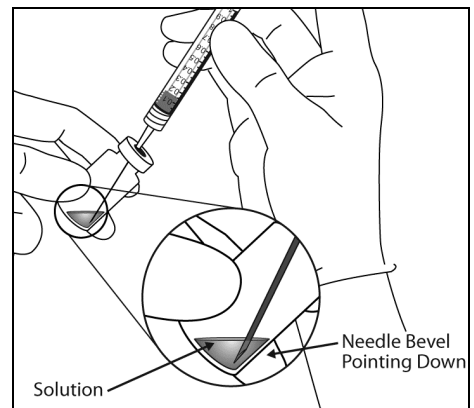
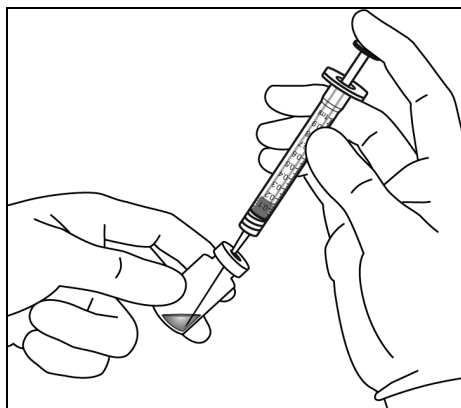

5. Ensure that the plunger rod is drawn sufficiently back when emptying the vial in order to completely empty the filter needle.
6. Remove the filter needle and properly dispose of it.
Note: Filter needle is not to be used for intravitreal injection.
7. Using aseptic technique, firmly twist a 30 G x ½ inch injection needle onto the Luer-lock syringe tip.

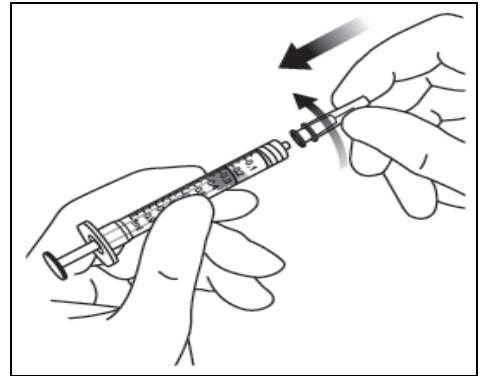

8. Holding the syringe with the needle pointing up, check the syringe for bubbles. If there are bubbles, gently tap the syringe with your finger until the bubbles rise to the top.

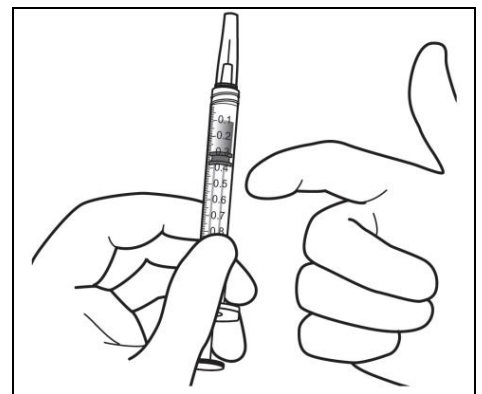

9. Eliminate all bubbles and expel excess medicinal product by slowly depressing the plunger so that the plunger tip aligns with the line that marks 0.05 ml on the syringe.

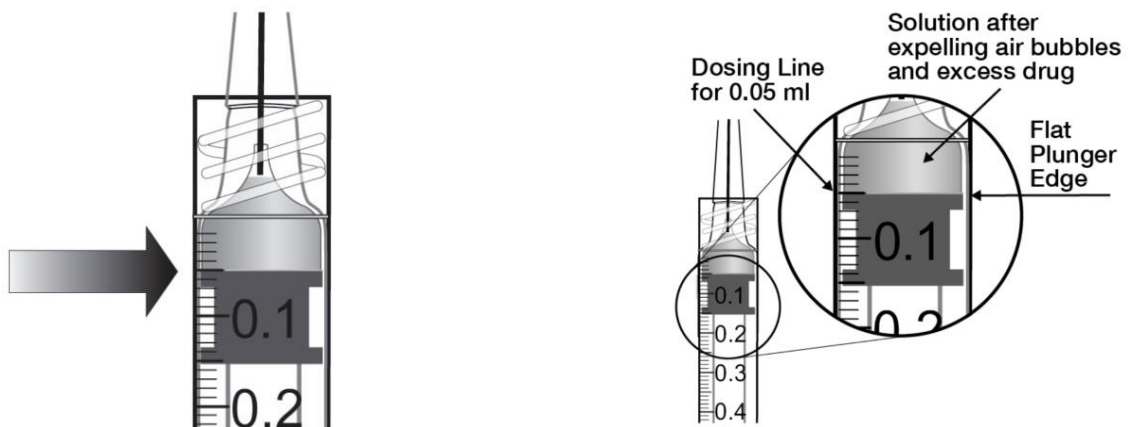

10. The vial is for single use only. Extraction of multiple doses from a single vial may increase the risk of contamination and subsequent infection.
Any unused medicinal product or waste material should be disposed of in accordance with local requirements.

7. MANUFACTURER

Bayer AG, Berlin, Germany

8. REGISTRATION HOLDER

Bayer Israel Ltd, 36 Hacharash St., Hod Hasharon 45240

Revised on March 2021 according to MoH guidelines