

1. NAME OF THE MEDICINAL PRODUCT

Erelzi[®] 25 solution for injection in pre-filled syringe.

Erelzi[®] 50 solution for injection in pre-filled syringe.

Erelzi[®] 50 solution for injection in pre-filled pen.

2. QUALITATIVE AND QUANTITATIVE COMPOSITION

Erelzi[®] 25 solution for injection in pre-filled syringe

Each pre-filled syringe contains 25 mg of etanercept.

Erelzi[®] 50 solution for injection in pre-filled syringe

Each pre-filled syringe contains 50 mg of etanercept.

Erelzi[®] 50 solution for injection in pre-filled pen

Each pre-filled pen contains 50 mg of etanercept.

Etanercept is a human tumour necrosis factor receptor p75 Fc fusion protein produced by recombinant DNA technology in a Chinese hamster ovary (CHO) mammalian expression system.

For the full list of excipients, see section 6.1.

Patient safety information Card

The marketing of Erelzi[®] is subject to a risk management plan (RMP), which includes a 'Patient safety information card'. The 'Patient safety information card' emphasizes important safety information that the patient should be aware of before and during treatment. Please explain to the patient the need to review the card before starting treatment.

3. PHARMACEUTICAL FORM

Solution for injection.

The solution is clear or slightly opalescent, colorless to slightly yellowish.

Erelzi[®] is a biosimilar medicinal product that has been demonstrated to be similar in quality, safety and efficacy to the reference medicinal product Enbrel. Please be aware of any differences in the indications between the biosimilar medicinal product and the reference medicinal product. The biosimilar is not to be switched with the reference medicinal product unless specifically stated otherwise. More detailed information regarding biosimilar medicinal products is available on the website of the Ministry of Health: <https://www.health.gov.il/UnitsOffice/HD/MTI/Drugs/Registration/Pages/Biosimilars.aspx>

4. CLINICAL PARTICULARS

4.1 Therapeutic indications

Rheumatoid arthritis

Erelzi is indicated for the treatment of active rheumatoid arthritis in adults when the response to disease-modifying antirheumatic drugs (DMARDs) including methotrexate (unless contraindicated) has been inadequate.

Erelzi can be used in combination with methotrexate in patients who do not respond adequately to methotrexate alone.

Reducing signs and symptoms and inhibiting the progression of structural damage in patients with moderately to severely active rheumatoid arthritis.

Etanercept, alone or in combination with methotrexate, has been shown to reduce the rate of progression of joint damage as measured by X-ray and to improve physical function.

Juvenile idiopathic arthritis

Treatment of polyarthritis (rheumatoid factor positive or negative) and extended oligoarthritis in children and adolescents from the age of 2 years who have had an inadequate response to, or who have proved intolerant of, methotrexate.

Treatment of psoriatic arthritis in adolescents from the age of 12 years who have had an inadequate response to, or who have proved intolerant of, methotrexate.

Treatment of enthesitis-related arthritis in adolescents from the age of 12 years who have had an inadequate response to, or who have proved intolerant of, conventional therapy.

Etanercept has not been studied in children aged less than 2 years

Psoriatic arthritis

Treatment of active and progressive psoriatic arthritis in adults when the response to previous disease-modifying antirheumatic drug therapy has been inadequate. Etanercept has been shown to improve physical function in patients with psoriatic arthritis, and to reduce the rate of progression of peripheral joint damage as measured by X-ray in patients with polyarticular symmetrical subtypes of the disease.

Axial spondyloarthritis

Ankylosing spondylitis (AS)

Treatment of adults with severe active ankylosing spondylitis who have had an inadequate response to conventional therapy.

Non-radiographic axial spondyloarthritis

Treatment of adults with severe non-radiographic axial spondyloarthritis with objective signs of inflammation as indicated by elevated C-reactive protein (CRP) and/or magnetic resonance imaging (MRI) evidence, who have had an inadequate response to

non-steroidal anti-inflammatory drugs (NSAIDs).

Plaque psoriasis

Treatment of adults patients (18 years or older) with moderate to severe plaque psoriasis who are candidates for systemic therapy or phototherapy.

Paediatric plaque psoriasis

Treatment of chronic severe plaque psoriasis in children and adolescents from the age of 6 years who are inadequately controlled by, or are intolerant to, other systemic therapies or phototherapies.

4.2 Posology and method of administration

Erelzi treatment should be initiated and supervised by specialist physicians experienced in the diagnosis and treatment of rheumatoid arthritis, juvenile idiopathic arthritis, psoriatic arthritis, ankylosing spondylitis, non-radiographic axial spondyloarthritis, plaque psoriasis or paediatric plaque psoriasis.

Erelzi pre filled syringe is available in strengths of 25 mg and 50 mg. The Erelzi pre-filled pen is available in a 50 mg strength.

Posology

Rheumatoid arthritis

Etanercept 25 mg administered twice weekly is the recommended dose. Alternatively, 50 mg administered once weekly has been shown to be safe and effective (see section 5.1).

Psoriatic arthritis, ankylosing spondylitis and non-radiographic axial spondyloarthritis

The recommended dose is 25 mg etanercept administered twice weekly, or 50 mg administered once weekly.

For all of the above indications, available data suggest that a clinical response is usually achieved within 12 weeks of treatment. Continued therapy should be carefully reconsidered in a patient not responding within this time period.

Plaque psoriasis

The recommended dose of etanercept is 25 mg administered twice weekly or 50 mg administered once weekly. Alternatively, 50 mg given twice weekly may be used for up to 12 weeks followed, if necessary, by a dose of 25 mg twice weekly or 50 mg once weekly. Treatment with etanercept should continue until remission is achieved, for up to 24 weeks. Continuous therapy beyond 24 weeks may be appropriate for some adult patients (see section 5.1).

Treatment should be discontinued in patients who show no response after 12 weeks. If re-treatment with etanercept is indicated, the same guidance on treatment duration should be followed. The dose should be 25 mg twice weekly or 50 mg once weekly.

Special populations

Renal and hepatic impairment

No dose adjustment is required.

Elderly

No dose adjustment is required. Posology and administration are the same as for adults 18-64 years of age.

Paediatric population

Erelzi is only available as 25 mg pre-filled syringe and 50 mg pre-filled syringe and pre-filled pen. Thus, it is not possible to administer Erelzi to paediatric patients that require less than a full 25 mg or 50 mg dose. Paediatric patients who require a dose other than a full 25 mg or 50 mg should not receive Erelzi. If an alternate dose is required, other etanercept products offering such an option should be used.

The dosage of etanercept is based on body weight for paediatric patients. Patients weighing less than 62.5 kg should be accurately dosed on a mg/kg basis using the powder and solvent for solution for injection presentations or the powder for solution for injection presentations (see below for dosing for specific indications). Patients weighing 62.5 kg or more, may be dosed using a fixed-dose pre-filled syringe or pre-filled pen.

Juvenile idiopathic arthritis

The recommended dose is 0.4 mg/kg (up to a maximum of 25 mg per dose), given twice weekly as a subcutaneous injection with an interval of 3-4 days between doses or 0.8 mg/kg (up to a maximum of 50 mg per dose) given once weekly. Discontinuation of treatment should be considered in patients who show no response after 4 months.

A 10 mg vial strength may be more appropriate for administration to children with JIA below the weight of 25 kg.

No formal clinical trials have been conducted in children aged 2 to 3 years. However, limited safety data from a patient registry suggest that the safety profile in children from 2 to 3 years of age is similar to that seen in adults and children aged 4 years and older, when dosed every week with 0.8 mg/kg subcutaneously (see section 5.1).

There is generally no applicable use of etanercept in children aged below 2 years in the indication juvenile idiopathic arthritis.

Paediatric plaque psoriasis (age 6 years and above)

The recommended dose is 0.8 mg/kg (up to a maximum of 50 mg per dose) once weekly for up to 24 weeks. Treatment should be discontinued in patients who show no response after 12 weeks.

If re-treatment with etanercept is indicated, the above guidance on treatment duration

should be followed. The dose should be 0.8 mg/kg (up to a maximum of 50 mg per dose) once weekly.

There is generally no applicable use of etanercept in children aged below 6 years in the indication plaque psoriasis.

Method of administration

Erelzi is administered by subcutaneous injection (see section 6.6).

Comprehensive instructions for administration are given in the package leaflet, section 7, "Instructions for use of the Erelzi pre-filled syringe" or "Instructions for use of the Erelzi SensoReady pen".

4.3 Contraindications

Hypersensitivity to the active substance or to any of the excipients listed in section 6.1. Sepsis or risk of sepsis.

Treatment with Erelzi should not be initiated in patients with active infections, including chronic or localised infections.

4.4 Special warnings and precautions for use

In order to improve the traceability of biological medicinal products, it is advised that the trademark and the batch number of the administered product should be clearly recorded (or stated) in the patient file.

Infections

Patients should be evaluated for infections before, during, and after treatment with Erelzi, taking into consideration that the mean elimination half-life of etanercept is approximately 70 hours (range 7 to 300 hours).

Serious infections, sepsis, tuberculosis, and opportunistic infections, including invasive fungal infections, listeriosis and legionellosis, have been reported with the use of etanercept (see section 4.8).

These infections were due to bacteria, mycobacteria, fungi, viruses and parasites (including protozoa).

In some cases, particular fungal and other opportunistic infections have not been recognised, resulting in delay of appropriate treatment and sometimes death. In evaluating patients for infections, the patient's risk for relevant opportunistic infections (e.g., exposure to endemic mycoses) should be considered.

Patients who develop a new infection while undergoing treatment with Erelzi should be monitored closely. Administration of Erelzi should be discontinued if a patient develops a serious infection. The safety and efficacy of etanercept in patients with

chronic infections have not been evaluated. Physicians should exercise caution when considering the use of Erelzi in patients with a history of recurring or chronic infections or with underlying conditions that may predispose patients to infections, such as advanced or poorly controlled diabetes.

Tuberculosis

Cases of active tuberculosis, including miliary tuberculosis and tuberculosis with extrapulmonary location, have been reported in patients treated with etanercept.

Before starting treatment with Erelzi, all patients must be evaluated for both active and inactive ('latent') tuberculosis. This evaluation should include a detailed medical history with personal history of tuberculosis or possible previous contact with tuberculosis and previous and/or current immunosuppressive therapy. Appropriate screening tests, i.e., tuberculin skin test and chest X-ray, should be performed in all patients (local recommendations may apply). It is recommended that the conduct of these tests should be recorded in the Patient Safety Information Card. Prescribers are reminded of the risk of false negative tuberculin skin test results, especially in patients who are severely ill or immunocompromised.

If active tuberculosis is diagnosed, Erelzi therapy must not be initiated. If inactive ('latent') tuberculosis is diagnosed, treatment for latent tuberculosis must be started with anti-tuberculosis therapy before the initiation of Erelzi, and in accordance with local recommendations. In this situation, the benefit/risk balance of Erelzi therapy should be very carefully considered.

All patients should be informed to seek medical advice if signs/symptoms suggestive of tuberculosis (e.g., persistent cough, wasting/weight loss, low-grade fever) appear during or after Erelzi treatment.

Hepatitis B reactivation

Reactivation of hepatitis B in patients who were previously infected with the hepatitis B virus (HBV) and had received concomitant TNF-antagonists, including etanercept, has been reported. This includes reports of reactivation of hepatitis B in patients who were anti-HBc positive but HBsAg negative.

Patients should be tested for HBV infection before initiating treatment with Erelzi. For patients who test positive for HBV infection, consultation with a physician with expertise in the treatment of hepatitis B is recommended. Caution should be exercised when administering Erelzi in patients previously infected with HBV. These patients should be monitored for signs and symptoms of active HBV infection throughout therapy and for several weeks following termination of therapy. Adequate data from treating patients infected with HBV with anti-viral therapy in conjunction with TNF-antagonist therapy are not available. In patients who develop HBV infection, Erelzi should be stopped and effective anti-viral therapy with appropriate supportive treatment should be initiated.

Worsening of hepatitis C

There have been reports of worsening of hepatitis C in patients receiving etanercept. Erelzi should be used with caution in patients with a history of hepatitis C.

Concurrent treatment with anakinra

Concurrent administration of etanercept and anakinra has been associated with an increased risk of serious infections and neutropenia compared to etanercept alone. This combination has not demonstrated increased clinical benefit. Thus, the combined use of Erelzi and anakinra is not recommended (see sections 4.5 and 4.8).

Concurrent treatment with abatacept

In clinical studies, concurrent administration of abatacept and etanercept resulted in increased incidences of serious adverse events. This combination has not demonstrated increased clinical benefit; such use is not recommended (see section 4.5).

Allergic reactions

Allergic reactions associated with etanercept administration have been reported commonly. Allergic reactions have included angioedema and urticaria; serious reactions have occurred. If any serious allergic or anaphylactic reaction occurs, Erelzi therapy should be discontinued immediately and appropriate therapy initiated.

Immunosuppression

The possibility exists for TNF-antagonists, including Erelzi, to affect host defences against infections and malignancies since TNF mediates inflammation and modulates cellular immune responses. In a study of 49 adult patients with rheumatoid arthritis treated with etanercept, there was no evidence of depression of delayed-type hypersensitivity, depression of immunoglobulin levels, or change in enumeration of effector cell populations.

Two juvenile idiopathic arthritis patients developed varicella infection and signs and symptoms of aseptic meningitis, which resolved without sequelae. Patients with a significant exposure to varicella virus should temporarily discontinue Erelzi therapy and be considered for prophylactic treatment with Varicella Zoster Immune Globulin.

The safety and efficacy of etanercept in patients with immunosuppression have not been evaluated.

Malignancies and lymphoproliferative disorders

Solid and haematopoietic malignancies (excluding skin cancers)

Reports of various malignancies (including breast and lung carcinoma and lymphoma) have been received in the post-marketing period (see section 4.8).

In the controlled portions of clinical trials of TNF-antagonists, more cases of lymphoma have been observed among patients receiving a TNF-antagonist compared with control patients. However, the occurrence was rare, and the follow-up period of placebo patients was shorter than for patients receiving TNF-antagonist therapy. In the postmarketing setting, cases of leukaemia have been reported in patients treated with TNF-antagonists. There is an increased background risk for lymphoma and leukaemia in rheumatoid arthritis patients with long-standing, highly active, inflammatory disease, which complicates risk estimation.

Based on current knowledge, a possible risk for the development of lymphomas, leukaemia or other haematopoietic or solid malignancies in patients treated with a TNF-antagonist cannot be excluded. Caution should be exercised when considering TNF-antagonist therapy for patients with a history of malignancy or when considering continuing treatment in patients who develop a malignancy.

Malignancies, some fatal, have been reported among children, adolescents and young adults (up to 22 years of age) treated with TNF-antagonists (initiation of therapy \leq 18 years of age), including etanercept, in the postmarketing setting. Approximately half the cases were lymphomas. The other cases represented a variety of different malignancies and included rare malignancies typically associated with immunosuppression. A risk for the development of malignancies in children and adolescents treated with TNF-antagonists cannot be excluded.

Skin cancers

Melanoma and non-melanoma skin cancer (NMSC) have been reported in patients treated with TNF-antagonists, including etanercept. Postmarketing cases of Merkel cell carcinoma have been reported very infrequently in patients treated with etanercept. Periodic skin examination is recommended for all patients, particularly those with risk factors for skin cancer.

Combining the results of controlled clinical trials, more cases of NMSC were observed in patients receiving etanercept compared with control patients, particularly in patients with psoriasis.

Vaccinations

Live vaccines should not be given concurrently with Erelzi. No data are available on the secondary transmission of infection by live vaccines in patients receiving etanercept. In a double-blind, placebo-controlled, randomised clinical study in adult patients with psoriatic arthritis, 184 patients also received a multivalent pneumococcal polysaccharide vaccine at week 4. In this study, most psoriatic arthritis patients receiving etanercept were able to mount effective B-cell immune response to pneumococcal polysaccharide vaccine, but titres in aggregate were moderately lower, and few patients had two-fold rises in titres compared to patients not receiving etanercept. The clinical significance of this is unknown.

Autoantibody formation

Treatment with Erelzi may result in the formation of autoimmune antibodies (see section 4.8).

Haematologic reactions

Rare cases of pancytopenia and very rare cases of aplastic anaemia, some with fatal outcome, have been reported in patients treated with etanercept. Caution should be exercised in patients being treated with Erelzi who have a previous history of blood dyscrasias. All patients and parents/caregivers should be advised that if the patient develops signs and symptoms suggestive of blood dyscrasias or infections (e.g., persistent fever, sore throat, bruising, bleeding, paleness) whilst on Erelzi, they should seek immediate medical advice. Such patients should be investigated urgently, including full blood count; if blood dyscrasias are confirmed, Erelzi should be discontinued.

Neurological disorders

There have been rare reports of CNS demyelinating disorders in patients treated with etanercept (see section 4.8). Additionally, there have been rare reports of peripheral demyelinating polyneuropathies (including Guillain-Barré syndrome, chronic inflammatory demyelinating polyneuropathy, demyelinating polyneuropathy, and multifocal motor neuropathy). Although no clinical trials have been performed evaluating etanercept therapy in patients with multiple sclerosis, clinical trials of other TNF antagonists in patients with multiple sclerosis have shown increases in disease activity. A careful risk/benefit evaluation, including a neurologic assessment, is recommended when prescribing Erelzi to patients with pre-existing or recent onset of demyelinating disease, or to those who are considered to have an increased risk of developing demyelinating disease.

Combination therapy

In a controlled clinical trial of two years duration in rheumatoid arthritis patients, the combination of etanercept and methotrexate did not result in unexpected safety findings, and the safety profile of etanercept when given in combination with methotrexate was similar to the profiles reported in studies of etanercept and methotrexate alone. Long-term studies to assess the safety of the combination are ongoing. The long-term safety of etanercept in combination with other disease-modifying antirheumatic drugs (DMARD) has not been established.

The use of etanercept in combination with other systemic therapies or phototherapy for the treatment of psoriasis has not been studied.

Renal and hepatic impairment

Based on pharmacokinetic data (see section 5.2), no dose adjustment is needed in patients with renal or hepatic impairment; clinical experience in such patients is limited.

Congestive heart failure (Cardiac failure congestive)

Physicians should use caution when using Erelzi in patients who have congestive heart

failure (CHF). There have been postmarketing reports of worsening of CHF, with and without identifiable precipitating factors, in patients taking etanercept. There have also been rare (< 0.1%) reports of new onset CHF, including CHF in patients without known pre-existing cardiovascular disease. Some of these patients have been under 50 years of age. Two large clinical trials evaluating the use of etanercept in the treatment of CHF were terminated early due to lack of efficacy. Although not conclusive, data from one of these trials suggest a possible tendency toward worsening CHF in those patients assigned to etanercept treatment.

Alcoholic hepatitis

In a phase II randomised placebo-controlled study of 48 hospitalised patients treated with etanercept or placebo for moderate to severe alcoholic hepatitis, etanercept was not efficacious, and the mortality rate in patients treated with etanercept was significantly higher after 6 months. Consequently, Erelzi should not be used in patients for the treatment of alcoholic hepatitis. Physicians should use caution when using Erelzi in patients who also have moderate to severe alcoholic hepatitis.

Wegener's granulomatosis

A placebo-controlled trial, in which 89 adult patients were treated with etanercept in addition to standard therapy (including cyclophosphamide or methotrexate, and glucocorticoids) for a median duration of 25 months, has not shown etanercept to be an effective treatment for Wegener's granulomatosis. The incidence of non-cutaneous malignancies of various types was significantly higher in patients treated with etanercept than in the control group. Etanercept is not recommended for the treatment of Wegener's granulomatosis.

Hypoglycaemia in patients treated for diabetes

There have been reports of hypoglycaemia following initiation of etanercept in patients receiving medications for diabetes, necessitating a reduction in anti-diabetic medications in some of these patients.

Special populations

Elderly

In the Phase 3 studies in rheumatoid arthritis, psoriatic arthritis, and ankylosing spondylitis, no overall differences in adverse events, serious adverse events, and serious infections in patients age 65 or older who received etanercept were observed compared with younger patients. However, caution should be exercised when treating the elderly and particular attention paid with respect to occurrence of infections.

Paediatric population

Vaccinations

It is recommended that paediatric patients, if possible, be brought up to date with all immunisations in agreement with current immunisation guidelines prior to initiating Erelzi therapy (see Vaccinations, above).

Erelzi contains sodium

This medicinal product contains less than 1 mmol sodium (23 mg) per 25mg or 50 mg, that is to say essentially 'sodium-free'.

4.5 Interaction with other medicinal products and other forms of interaction

Concurrent treatment with anakinra

Adult patients treated with etanercept and anakinra were observed to have a higher rate of serious infection when compared with patients treated with either etanercept or anakinra alone (historical data).

In addition, in a double-blind, placebo-controlled trial in adult patients receiving background methotrexate, patients treated with etanercept and anakinra were observed to have a higher rate of serious infections (7%) and neutropenia than patients treated with etanercept (see sections 4.4 and 4.8). The combination etanercept and anakinra has not demonstrated increased clinical benefit, and is therefore not recommended.

Concurrent treatment with abatacept

In clinical studies, concurrent administration of abatacept and etanercept resulted in increased incidences of serious adverse events. This combination has not demonstrated increased clinical benefit; such use is not recommended (see section 4.4).

Concurrent treatment with sulfasalazine

In a clinical study of adult patients who were receiving established doses of sulfasalazine, to which etanercept was added, patients in the combination group experienced a statistically significant decrease in mean white blood cell counts in comparison to groups treated with etanercept or sulfasalazine alone.

The clinical significance of this interaction is unknown. Physicians should use caution when considering combination therapy with sulfasalazine.

Non-interactions

In clinical trials, no interactions have been observed when etanercept was administered with glucocorticoids, salicylates (except sulfasalazine), non-steroidal anti-inflammatory drugs (NSAIDs), analgesics, or methotrexate. See section 4.4 for vaccination advice.

No clinically significant pharmacokinetic drug-drug interactions were observed in studies with methotrexate, digoxin or warfarin.

4.6 Fertility, pregnancy and lactation

Women of childbearing potential

Women of childbearing potential should consider the use of appropriate contraception to avoid becoming pregnant during Erelzi therapy and for three weeks after discontinuation of therapy.

Pregnancy

Developmental toxicity studies performed in rats and rabbits have revealed no evidence of harm to the foetus or neonatal rat due to etanercept. The effects of etanercept on pregnancy outcomes have been investigated in two observational cohort studies. A higher

rate of major birth defects was observed in one observational study comparing pregnancies exposed to etanercept (n=370) during the first trimester with pregnancies not exposed to etanercept or other TNF-antagonists (n=164) (adjusted odds ratio 2.4, 95% CI: 1.0-5.5). The types of major birth defects were consistent with those most commonly reported in the general population and no particular pattern of abnormalities was identified. No change in the rate of spontaneous abortion, stillbirth, or minor malformations was observed. In another observational multi-country registry study comparing the risk of adverse pregnancy outcomes in women exposed to etanercept during the first 90 days of pregnancy (n=425) to those exposed to non-biologic drugs (n=3497), there was no observed increased risk of major birth defects (crude odds ratio [OR]= 1.22, 95% CI: 0.79-1.90; adjusted OR = 0.96, 95% CI: 0.58-1.60 after adjusting for country, maternal disease, parity, maternal age and smoking in early pregnancy). This study also showed no increased risks of minor birth defects, preterm birth, stillbirth, or infections in the first year of life for infants born to women exposed to etanercept during pregnancy. Erelzi should only be used during pregnancy if clearly needed.

Etanercept crosses the placenta and has been detected in the serum of infants born to female patients treated with etanercept during pregnancy. The clinical impact of this is unknown, however, infants may be at increased risk of infection. Administration of live vaccines to infants for 16 weeks after the mother's last dose of Erelzi is generally not recommended.

Breast-feeding

Etanercept has been reported to be excreted in human milk following subcutaneous administration. In lactating rats following subcutaneous administration, etanercept was excreted in the milk and detected in the serum of pups. Because immunoglobulins, in common with many medicinal products, can be excreted in human milk, a decision must be made whether to discontinue breast-feeding or to discontinue Erelzi therapy, taking into account the benefit of breast-feeding for the child and the benefit of therapy for the woman.

Fertility

Preclinical data about peri- and postnatal toxicity of etanercept and of effects of etanercept on fertility and general reproductive performance are not available.

4.7 Effects on ability to drive and use machines

Erelzi has no or negligible influence on the ability to drive and use machines.

4.8 Undesirable effects

Summary of the safety profile

The most commonly reported adverse reactions are injection site reactions (such as pain, swelling, itching, reddening and bleeding at the puncture site), infections (such as upper respiratory infections, bronchitis, bladder infections and skin infections), headache, allergic reactions, development of autoantibodies, itching, and fever.

Serious adverse reactions have also been reported for etanercept. TNF-antagonists, such as etanercept, affect the immune system and their use may affect the body's defenses against infection and cancer. Serious infections affect fewer than 1 in 100 patients treated with etanercept. Reports have included fatal and life-threatening infections and sepsis. Various malignancies have also been reported with use of etanercept, including cancers of the breast, lung, skin and lymph glands (lymphoma).

Serious haematological, neurological and autoimmune reactions have also been reported. These include rare reports of pancytopenia and very rare reports of aplastic anaemia. Central and peripheral demyelinating events have been seen rarely and very rarely, respectively, with etanercept use. There have been rare reports of lupus, lupus-related conditions, and vasculitis.

Tabulated list of adverse reactions

The following list of adverse reactions is based on experience from clinical trials in adults and on postmarketing experience.

Within the system organ classes, adverse reactions are listed under headings of frequency (number of patients expected to experience the reaction), using the following categories: very common ($\geq 1/10$); common ($\geq 1/100$ to $< 1/10$); uncommon ($\geq 1/1,000$ to $< 1/100$); rare ($\geq 1/10,000$ to $< 1/1,000$); very rare ($< 1/10,000$); not known

System Organ Class	Very Common ≥ 1/10	Common ≥ 1/100 to < 1/10	Uncommon ≥ 1/1,000 to < 1/100	Rare ≥ 1/10,000 to < 1/1,000	Very Rare < 1/10,000	Frequency Not Known (Cannot be Estimated from Available Data)
Infections and infestations	Infection (including upper respiratory tract infection, bronchitis, cystitis, skin infection)*		Serious infections (including pneumonia, cellulitis, arthritis bacterial, sepsis and parasitic infection)*	Tuberculosis, opportunistic infection (including invasive fungal, protozoal, bacterial, atypical mycobacterial, viral infections, and Legionella)*		Hepatitis B reactivation, listeria
Neoplasms benign, malignant and unspecified (including cysts and polyps)			Non-melanoma skin cancers* (see section 4.4)	Malignant melanoma (see section 4.4), lymphoma, leukaemia		Merkel cell carcinoma (see section 4.4), Kaposi Sarcoma
Blood and lymphatic system disorders			Thrombocytopenia, anaemia, leukopenia, neutropenia	Pancytopenia*	Aplastic anaemia*	Histiocytosis haematophagic (macrophage activation syndrome)*
Immune system disorders		Allergic reactions (see Skin and subcutaneous tissue disorders), autoantibody formation*	Vasculitis (including anti-neutrophilic cytoplasmic antibody positive vasculitis)	Serious allergic/anaphylactic reactions (including angioedema, bronchospasm), sarcoidosis		Worsening of symptoms of dermatomyositis

System Organ Class	Very Common ≥ 1/10	Common ≥ 1/100 to < 1/10	Uncommon ≥ 1/1,000 to < 1/100	Rare ≥ 1/10,000 to < 1/1,000	Very Rare < 1/10,000	Frequency Not Known (Cannot be Estimated from Available Data)
Nervous system disorders	Headache			CNS demyelinating events suggestive of multiple sclerosis or localised demyelinating conditions, such as optic neuritis and transverse myelitis (see section 4.4), peripheral demyelinating events, including Guillain-Barré syndrome, chronic inflammatory demyelinating polyneuropathy, demyelinating polyneuropathy, and multifocal motor neuropathy (see section 4.4), seizure		
Eye disorders			Uveitis, scleritis			
Cardiac disorders			Worsening of cardiac failure congestive (see section 4.4)	New onset cardiac failure congestive (see section 4.4)		
Respiratory, thoracic, and mediastinal disorders				Interstitial lung disease (including pneumonitis and pulmonary fibrosis)*		
Hepatobiliary disorders			Elevated liver enzymes*	Autoimmune hepatitis*		

System Organ Class	Very Common ≥ 1/10	Common ≥ 1/100 to < 1/10	Uncommon ≥ 1/1,000 to < 1/100	Rare ≥ 1/10,000 to < 1/1,000	Very Rare < 1/10,000	Frequency Not Known (Cannot be Estimated from Available Data)
Skin and subcutaneous tissue disorders		Pruritus, rash	Angioedema, psoriasis (including new onset or worsening and pustular, primarily palms and soles), urticaria, psoriasiform rash	Stevens-Johnson syndrome, cutaneous vasculitis (including hypersensitivity vasculitis), erythema multiforme, lichenoid reactions	Toxic epidermal necrolysis	
Musculoskeletal and connective tissue disorders				Cutaneous lupus erythematosus, subacute cutaneous lupus erythematosus, lupus-like syndrome		
General disorders and administration site conditions	Injection site reactions (including bleeding, bruising, erythema, itching, pain, swelling)*	Pyrexia				
Gastrointestinal disorders			Inflammatory bowel disease			

*see Description of selected adverse reactions, below.

Description of selected adverse reactions

Malignancies and lymphoproliferative disorders

One hundred and twenty-nine (129) new malignancies of various types were observed in 4,114 rheumatoid arthritis patients treated in clinical trials with etanercept for up to approximately 6 years, including 231 patients treated with etanercept in combination with methotrexate in a 2-year active-controlled study. The observed rates and incidences in these clinical trials were similar to those expected for the population studied. A total of 2 malignancies were reported in clinical studies of approximately 2 years duration involving 240 etanercept-treated psoriatic arthritis patients. In clinical studies conducted for more than 2 years with 351 ankylosing spondylitis patients, 6 malignancies were reported in etanercept-treated patients. In a group of 2,711 plaque psoriasis patients treated with etanercept in double-blind and open-label studies of up

to 2.5 years, 30 malignancies and 43 non-melanoma skin cancers were reported.

In a group of 7,416 patients treated with etanercept in rheumatoid arthritis, psoriatic arthritis, ankylosing spondylitis and psoriasis clinical trials, 18 lymphomas were reported.

Reports of various malignancies (including breast and lung carcinoma and lymphoma) have also been received in the postmarketing period (see section 4.4).

Injection site reactions

Compared to placebo, patients with rheumatic diseases treated with etanercept had a significantly higher incidence of injection site reactions (36% vs. 9%). Injection site reactions usually occurred in the first month. Mean duration was approximately 3 to 5 days. No treatment was given for the majority of injection site reactions in the etanercept treatment groups, and the majority of patients who were given treatment received topical preparations, such as corticosteroids, or oral antihistamines.

Additionally, some patients developed recall injection site reactions characterised by a skin reaction at the most recent site of injection, along with the simultaneous appearance of injection site reactions at previous injection sites. These reactions were generally transient and did not recur with treatment.

In controlled trials in patients with plaque psoriasis, approximately 13.6% of patients treated with etanercept developed injection site reactions compared with 3.4% of placebo-treated patients during the first 12 weeks of treatment.

Serious infections

In placebo-controlled trials, no increase in the incidence of serious infections (fatal, life-threatening, or requiring hospitalisation or intravenous antibiotics) was observed. Serious infections occurred in 6.3% of rheumatoid arthritis patients treated with etanercept for up to 48 months. These included abscess (at various sites), bacteraemia, bronchitis, bursitis, cellulitis, cholecystitis, diarrhoea, diverticulitis, endocarditis (suspected), gastroenteritis, hepatitis B, herpes zoster, leg ulcer, mouth infection, osteomyelitis, otitis, peritonitis, pneumonia, pyelonephritis, sepsis, septic arthritis, sinusitis, skin infection, skin ulcer, urinary tract infection, vasculitis, and wound infection. In a 2-year active-controlled study where patients were treated with either etanercept alone, methotrexate alone or etanercept in combination with methotrexate, the rates of serious infections were similar among the treatment groups. However, it cannot be excluded that the combination of etanercept with methotrexate could be associated with an increase in the rate of infections.

There were no differences in rates of infection among patients treated with etanercept and those treated with placebo for plaque psoriasis in placebo-controlled trials of up to 24 weeks duration. Serious infections experienced by etanercept-treated patients included cellulitis, gastroenteritis, pneumonia, cholecystitis, osteomyelitis, gastritis, appendicitis, *Streptococcal* fasciitis, myositis, septic shock, diverticulitis and abscess. In the double-blind and open-label psoriatic arthritis trials, 1 patient reported a serious infection (pneumonia).

Serious and fatal infections have been reported during use of etanercept; reported pathogens include bacteria, mycobacteria (including tuberculosis), viruses and fungi. Some have occurred within a few weeks after initiating treatment with etanercept in patients who have underlying conditions (e.g., diabetes, congestive heart failure, history of active or chronic infections) in addition to their rheumatoid arthritis (see section 4.4). Etanercept treatment may increase mortality in patients with established sepsis.

Opportunistic infections have been reported in association with etanercept, including invasive fungal, parasitic (including protozoal), viral (including herpes zoster), bacterial (including *Listeria* and *Legionella*), and atypical mycobacterial infections. In a pooled data set of clinical trials, the overall incidence of opportunistic infections was 0.09% for the 15,402 subjects who received etanercept. The exposure-adjusted rate was 0.06 events per 100 patient-years. In postmarketing experience, approximately half of all of the case reports of opportunistic infections worldwide were invasive fungal infections. The most commonly reported invasive fungal infections included *Candida*, *Pneumocystis*, *Aspergillus* and *Histoplasma*. Invasive fungal infections accounted for more than half of the fatalities amongst patients who developed opportunistic infections. The majority of the reports with a fatal outcome were in patients with *Pneumocystis* pneumonia, unspecified systemic fungal infections, and aspergillosis (see section 4.4).

Autoantibodies

Adult patients had serum samples tested for autoantibodies at multiple timepoints. Of the rheumatoid arthritis patients evaluated for antinuclear antibodies (ANA), the percentage of patients who developed new positive ANA ($\geq 1:40$) was higher in patients treated with etanercept (11%) than in placebo-treated patients (5%). The percentage of patients who developed new positive anti-double-stranded DNA antibodies was also higher by radioimmunoassay (15% of patients treated with etanercept compared to 4% of placebo-treated patients) and by *Crithidia luciliae* assay (3% of patients treated with etanercept compared to none of placebo-treated patients). The proportion of patients treated with etanercept who developed anticardiolipin antibodies was similarly increased compared to placebo-treated patients. The impact of long-term treatment with etanercept on the development of autoimmune diseases is unknown.

There have been rare reports of patients, including rheumatoid factor positive patients, who have developed other autoantibodies in conjunction with a lupus-like syndrome or rashes that are compatible with subacute cutaneous lupus or discoid lupus by clinical presentation and biopsy.

Pancytopenia and aplastic anaemia

There have been postmarketing reports of pancytopenia and aplastic anaemia, some of which had fatal outcomes (see section 4.4).

Interstitial lung disease

In controlled clinical trials of etanercept across all indications, the frequency (incidence proportion) of interstitial lung disease in patients receiving etanercept without concomitant methotrexate was 0.06% (frequency rare). In the controlled clinical trials that allowed concomitant treatment with etanercept and methotrexate, the frequency (incidence proportion) of interstitial lung disease was 0.47% (frequency uncommon). There have been postmarketing reports of interstitial lung disease (including pneumonitis and pulmonary fibrosis), some of which had fatal outcomes.

Concurrent treatment with anakinra

In studies when adult patients received concurrent treatment with etanercept plus anakinra, a higher rate of serious infections compared to etanercept alone was observed and 2% of patients (3/139) developed neutropenia (absolute neutrophil count < 1,000/mm³). While neutropenic, one patient developed cellulitis that resolved after hospitalisation (see sections 4.4 and 4.5).

Elevated liver enzymes

In the double-blind periods of controlled clinical trials of etanercept across all indications, the frequency (incidence proportion) of adverse events of elevated liver enzymes in patients receiving etanercept without concomitant methotrexate was 0.54% (frequency uncommon). In the double-blind periods of controlled clinical trials that allowed concomitant treatment with etanercept and methotrexate, the frequency (incidence proportion) of adverse events of elevated liver enzymes was 4.18% (frequency common).

Autoimmune hepatitis

In controlled clinical trials of etanercept across all indications, the frequency (incidence proportion) of autoimmune hepatitis in patients receiving etanercept without concomitant methotrexate was 0.02% (frequency rare). In the controlled clinical trials that allowed concomitant treatment with etanercept and methotrexate, the frequency (incidence proportion) of autoimmune hepatitis was 0.24% (frequency uncommon).

Paediatric population

Undesirable effects in paediatric patients with juvenile idiopathic arthritis

In general, the adverse events in paediatric patients with juvenile idiopathic arthritis were similar in frequency and type to those seen in adult patients. Differences from adults and other special considerations are discussed in the following paragraphs.

The types of infections seen in clinical trials in juvenile idiopathic arthritis patients aged 2 to 18 years were generally mild to moderate and consistent with those commonly seen in outpatient paediatric populations. Severe adverse events reported included varicella with signs and symptoms of aseptic meningitis, which resolved without sequelae (see also section 4.4), appendicitis, gastroenteritis, depression/personality disorder,

cutaneous ulcer, oesophagitis/gastritis, group A streptococcal septic shock, type I diabetes mellitus, and soft tissue and post-operative wound infection.

In one study in children with juvenile idiopathic arthritis aged 4 to 17 years, 43 of 69 (62%) children experienced an infection while receiving etanercept during 3 months of the study (part 1, open-label), and the frequency and severity of infections was similar in 58 patients completing 12 months of open-label extension therapy. The types and proportion of adverse events in juvenile idiopathic arthritis patients were similar to those seen in trials of etanercept in adult patients with rheumatoid arthritis, and the majority were mild. Several adverse events were reported more commonly in 69 juvenile idiopathic arthritis patients receiving 3 months of etanercept compared to the 349 adult rheumatoid arthritis patients. These included headache (19% of patients, 1.7 events per patient year), nausea (9%, 1.0 event per patient year), abdominal pain (19%, 0.74 events per patient year), and vomiting (13%, 0.74 events per patient year).

There were 4 reports of macrophage activation syndrome in juvenile idiopathic arthritis clinical trials.

Undesirable effects in paediatric patients with plaque psoriasis

In a 48-week study in 211 children aged 4 to 17 years with paediatric plaque psoriasis, the adverse events reported were similar to those seen in previous studies in adults with plaque psoriasis.

Reporting of suspected adverse reactions

Reporting suspected adverse reactions after authorisation of the medicinal product is important. It allows continued monitoring of the benefit/risk balance of the medicinal product. Any suspected adverse events should be reported to the Ministry of Health according to the National Regulation by using an online form

<https://sideeffects.health.gov.il/>

4.9 Overdose

No dose-limiting toxicities were observed during clinical trials of rheumatoid arthritis patients. The highest dose level evaluated has been an intravenous loading dose of 32 mg/m² followed by subcutaneous doses of 16 mg/m² administered twice weekly. One rheumatoid arthritis patient mistakenly self-administered 62 mg etanercept subcutaneously twice weekly for 3 weeks without experiencing undesirable effects. There is no known antidote to etanercept.

5. PHARMACOLOGICAL PROPERTIES

5.1 Pharmacodynamic properties

Erelzi is a biosimilar medicinal product that has been demonstrated to be similar in quality, safety and efficacy to the reference medicinal product Enbrel. More detailed information is available on the website of the Ministry of Health

http://www.health.gov.il/hozer/dr_127.pdf

Pharmacotherapeutic group: Immunosuppressants, Tumour Necrosis Factor alpha (TNF- α) inhibitors, ATC code: L04AB01

Tumour necrosis factor (TNF) is a dominant cytokine in the inflammatory process of rheumatoid arthritis. Elevated levels of TNF are also found in the synovium and psoriatic plaques of patients with psoriatic arthritis and in serum and synovial tissue of patients with ankylosing spondylitis. In plaque psoriasis, infiltration by inflammatory cells, including T- cells, leads to increased TNF levels in psoriatic lesions compared with levels in uninvolved skin. Etanercept is a competitive inhibitor of TNF binding to its cell surface receptors, and thereby inhibits the biological activity of TNF. TNF and lymphotoxin are pro-inflammatory cytokines that bind to two distinct cell surface receptors: the 55-kilodalton (p55) and 75-kilodalton (p75) tumour necrosis factor receptors (TNFRs). Both TNFRs exist naturally in membrane-bound and soluble forms. Soluble TNFRs are thought to regulate TNF biological activity.

TNF and lymphotoxin exist predominantly as homotrimers, with their biological activity dependent on cross-linking of cell surface TNFRs. Dimeric soluble receptors, such as etanercept, possess a higher affinity for TNF than monomeric receptors and are considerably more potent competitive inhibitors of TNF binding to its cellular receptors. In addition, use of an immunoglobulin Fc region as a fusion element in the construction of a dimeric receptor imparts a longer serum half-life.

Mechanism of action

Much of the joint pathology in rheumatoid arthritis and ankylosing spondylitis and skin pathology in plaque psoriasis is mediated by pro-inflammatory molecules that are linked in a network controlled by TNF. The mechanism of action of etanercept is thought to be its competitive inhibition of TNF binding to cell surface TNFR, preventing TNF-mediated cellular responses by rendering TNF biologically inactive. Etanercept may also modulate biologic responses controlled by additional downstream molecules (e.g., cytokines, adhesion molecules, or proteinases) that are induced or regulated by TNF.

Clinical efficacy and safety

This section presents data from four randomised controlled trials in adults with rheumatoid arthritis, one study in adults with psoriatic arthritis, one study in adults with ankylosing spondylitis, one study in adults with non-radiographic axial spondyloarthritis, four studies in adults with plaque psoriasis, three studies in

juvenile idiopathic arthritis and one study in paediatric patients with plaque psoriasis.

Adult patients with rheumatoid arthritis

The efficacy of etanercept was assessed in a randomised, double-blind, placebo-controlled study. The study evaluated 234 adult patients with active rheumatoid arthritis who had failed therapy with at least one but no more than four disease-modifying antirheumatic drugs (DMARDs).

Doses of 10 mg or 25 mg etanercept or placebo were administered subcutaneously twice a week for 6 consecutive months. The results of this controlled trial were expressed in percentage improvement in rheumatoid arthritis using American College of Rheumatology (ACR) response criteria.

ACR 20 and 50 responses were higher in patients treated with etanercept at 3 and 6 months than in patients treated with placebo (ACR 20: etanercept 62% and 59%, placebo 23% and 11% at 3 and 6 months, respectively; ACR 50: etanercept 41% and 40%, placebo 8% and 5% at months 3 and 6, respectively; $p < 0.01$ etanercept vs. placebo at all timepoints for both ACR 20 and ACR 50 responses).

Approximately 15% of subjects who received etanercept achieved an ACR 70 response at month 3 and month 6 compared to fewer than 5% of subjects in the placebo arm. Among patients receiving etanercept, the clinical responses generally appeared within 1 to 2 weeks after initiation of therapy and nearly always occurred by 3 months. A dose response was seen; results with 10 mg were intermediate between placebo and 25 mg. Etanercept was significantly better than placebo in all components of the ACR criteria, as well as other measures of rheumatoid arthritis disease activity not included in the ACR response criteria, such as morning stiffness. A Health Assessment Questionnaire (HAQ), which included disability, vitality, mental health, general health status, and arthritis-associated health status subdomains, was administered every 3 months during the trial. All subdomains of the HAQ were improved in patients treated with etanercept compared to controls at 3 and 6 months.

After discontinuation of etanercept, symptoms of arthritis generally returned within a month. Re-introduction of treatment with etanercept after discontinuation of up to 24 months resulted in the same magnitudes of responses as patients who received etanercept without interruption of therapy based on results of open-label studies. Continued durable responses have been seen for up to 10 years in open-label extension treatment trials when patients received etanercept without interruption.

The efficacy of etanercept was compared to methotrexate in a randomised, active-controlled study with blinded radiographic evaluations as a primary endpoint in 632 adult patients with active rheumatoid arthritis (<3 years duration) who had never received treatment with methotrexate. Doses of 10 mg or 25 mg etanercept were administered subcutaneously (SC) twice a week for up to 24 months. Methotrexate doses were escalated from 7.5 mg/week to a maximum of 20 mg/week over the first 8 weeks of the trial and continued for up to 24 months. Clinical improvement,

including onset of action within 2 weeks with etanercept 25 mg, was similar to that seen in the previous trials and was maintained for up to 24 months. At baseline, patients had a moderate degree of disability, with mean HAQ scores of 1.4 to 1.5. Treatment with etanercept 25 mg resulted in substantial improvement at 12 months, with about 44% of patients achieving a normal HAQ score (less than 0.5). This benefit was maintained in Year 2 of this study.

In this study, structural joint damage was assessed radiographically and expressed as change in Total Sharp Score (TSS) and its components, the erosion score and Joint Space Narrowing (JSN) score. Radiographs of hands/wrists and feet were read at baseline and 6, 12, and 24 months. The 10 mg etanercept dose had consistently less effect on structural damage than the 25 mg dose. Etanercept 25 mg was significantly superior to methotrexate for erosion scores at both 12 and 24 months. The differences in TSS and JSN were not statistically significant between methotrexate and etanercept 25 mg. The results are shown in the figure below.

Radiographic Progression: Comparison of etanercept vs. Methotrexate in Patients with RA of <3 Years Duration

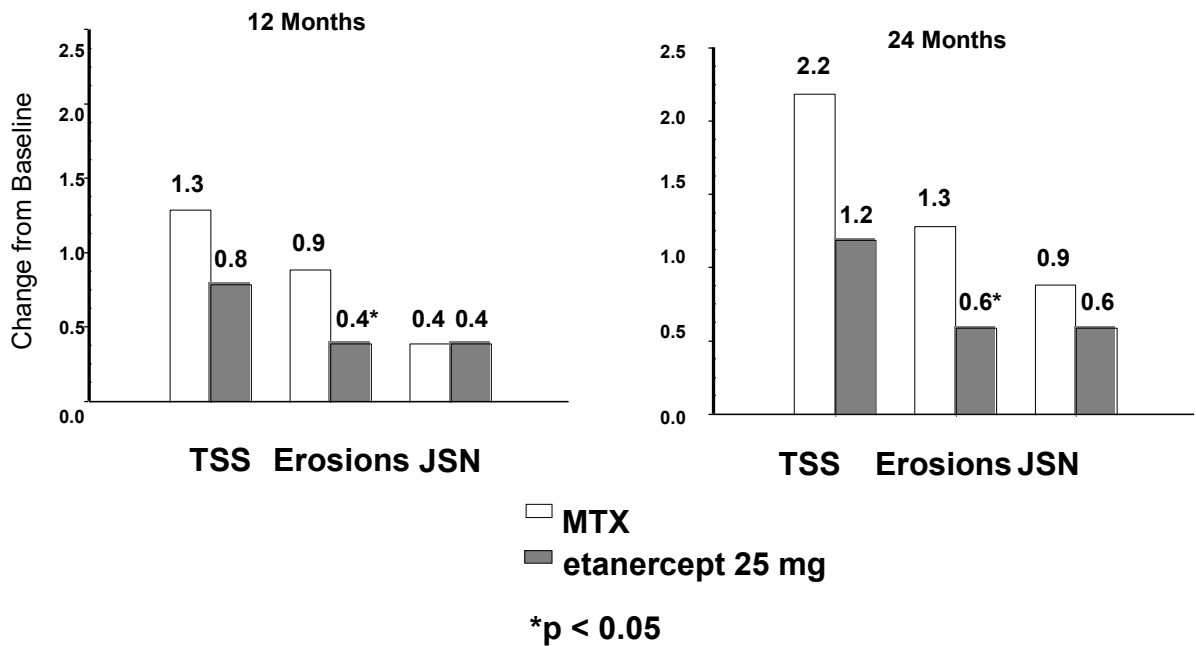

In another active-controlled, double-blind, randomised study, clinical efficacy, safety, and radiographic progression in RA patients treated with etanercept alone (25 mg twice weekly), methotrexate alone (7.5 to 20 mg weekly, median dose 20 mg), and the combination of etanercept and methotrexate initiated concurrently were compared in 682 adult patients with active rheumatoid arthritis of 6 months to 20 years duration (median 5 years) who had a less than satisfactory response to at least 1 disease-modifying antirheumatic drug (DMARD) other than methotrexate.

Patients in the etanercept in combination with methotrexate therapy group had significantly higher ACR 20, ACR 50, ACR 70 responses and improvement for DAS and HAQ scores at both 24 and 52 weeks than patients in either of the single therapy groups (results shown in table below). Significant advantages for etanercept in combination with methotrexate compared with etanercept monotherapy and methotrexate monotherapy were also observed after 24 months.

Clinical Efficacy Results at 12 Months: Comparison of etanercept vs. methotrexate vs. etanercept in Combination with methotrexate in Patients with RA of 6 Months To 20 Years Duration

Endpoint	Methotrexate (n = 228)	Etanercept (n=223)	Etanercept+ Methotrexate (n = 231)
ACR Responses^a			
ACR 20	58.8%	65.5%	74.5% †,ϕ
ACR 50	36.4%	43.0%	63.2% †,ϕ
ACR 70	16.7%	22.0%	39.8% †,ϕ
DAS			
Baseline	5.5	5.7	5.5
Week	3.0	3.0	2.3†,ϕ
52 score ^b			
Remission ^c	14%	18%	37%†,ϕ
HAQ			
Baseline	1.7	1.7	1.8
Week 52	1.1	1.0	0.8†,□

a: Patients who did not complete 12 months in the study were considered to be non-responders.

b: Values for Disease Activity Score (DAS) are means.

c: Remission is defined as DAS <1.6.

Pairwise comparison p-values: † = $p < 0.05$ for comparisons of etanercept + methotrexate vs. methotrexate and $\phi = p < 0.05$ for comparisons of etanercept + methotrexate vs. etanercept.

Radiographic progression at 12 months was significantly less in the etanercept group than in the methotrexate group, while the combination was significantly better than either monotherapy at slowing radiographic progression (see figure below).

Radiographic progression: comparison of etanercept vs. methotrexate vs. etanercept in combination with methotrexate in patients with RA of 6 months to 20 years duration (12 month results)

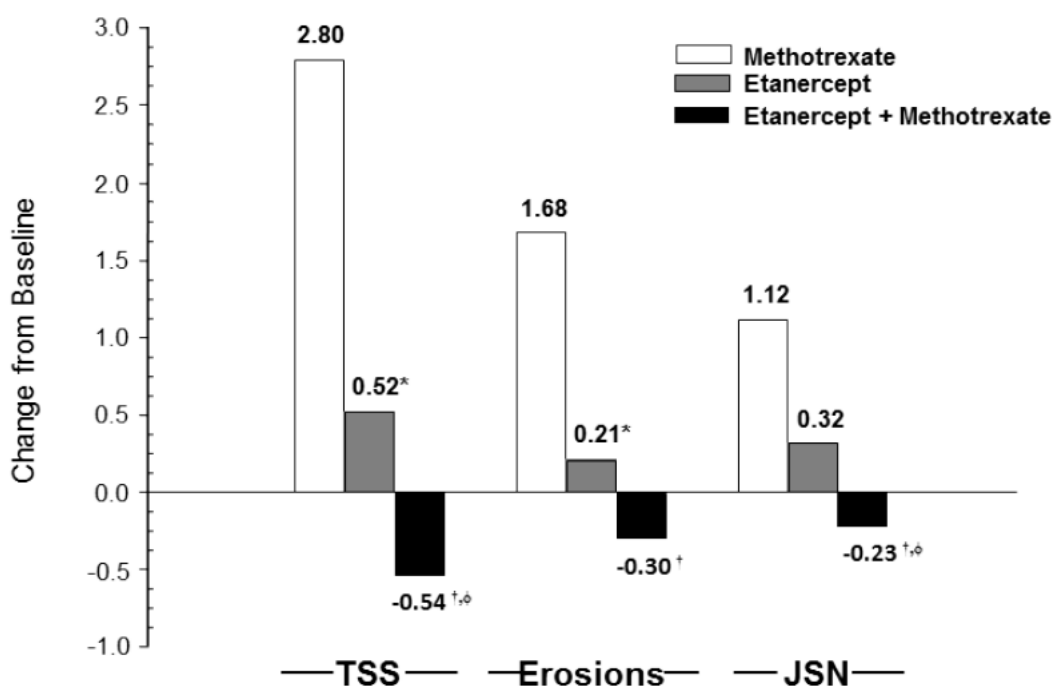

Pairwise comparison p-values: * = $p < 0.05$ for comparisons of etanercept vs. methotrexate, † = $p < 0.05$ for comparisons of etanercept + methotrexate vs. methotrexate and $\phi = p < 0.05$ for comparisons of etanercept + methotrexate vs. etanercept.

Significant advantages for etanercept in combination with methotrexate compared with etanercept monotherapy and methotrexate monotherapy were also observed after 24 months. Similarly, the significant advantages for etanercept monotherapy compared with methotrexate monotherapy were also observed after 24 months.

In an analysis in which all patients who dropped out of the study for any reason were considered to have progressed, the percentage of patients without progression (TSS change ≤ 0.5) at 24 months was higher in the etanercept in combination with methotrexate group compared with the etanercept alone and methotrexate alone groups (62%, 50%, and 36%, respectively; $p < 0.05$). The difference between etanercept alone and methotrexate alone was also significant ($p < 0.05$).

Among patients who completed a full 24 months of therapy in the study, the non- progression rates were 78%, 70%, and 61%, respectively.

The safety and efficacy of 50 mg etanercept (two 25 mg SC injections) administered once weekly were evaluated in a double-blind, placebo-controlled study of 420 patients with active RA. In this study, 53 patients received placebo, 214 patients received 50 mg etanercept once weekly and 153 patients received 25 mg etanercept twice weekly. The safety and efficacy profiles of the two etanercept treatment regimens were comparable at week 8 in their effect on signs and symptoms of RA; data at week 16 did not show comparability (non-inferiority) between the two regimens. A single 50 mg/ml injection of etanercept was found to be bioequivalent to two simultaneous injections of 25 mg/ml.

Adult patients with psoriatic arthritis

The efficacy of etanercept was assessed in a randomised, double-blind, placebo-controlled study in 205 patients with psoriatic arthritis. Patients were between 18 and 70 years of age and had active psoriatic arthritis (≥ 3 swollen joints and ≥ 3 tender joints) in at least one of the following forms: (1) distal interphalangeal (DIP) involvement; (2) polyarticular arthritis (absence of rheumatoid nodules and presence of psoriasis); (3) arthritis mutilans; (4) asymmetric psoriatic arthritis; or (5) spondylitis-like ankylosis. Patients also had plaque psoriasis with a qualifying target lesion ≥ 2 cm in diameter. Patients had previously been treated with NSAIDs (86%), DMARDs (80%), and corticosteroids (24%). Patients currently on methotrexate therapy (stable for ≥ 2 months) could continue at a stable dose of ≤ 25 mg/week methotrexate. Doses of 25 mg of etanercept (based on dose-finding studies in patients with rheumatoid arthritis) or placebo were administered SC twice a week for 6 months. At the end of the double-blind study, patients could enter a long-term open-label extension study for a total duration of up to 2 years.

Clinical responses were expressed as percentages of patients achieving the ACR 20, 50, and 70 response and percentages with improvement in Psoriatic Arthritis Response Criteria (PsARC). Results are summarised in the table below.

Responses of Patients with Psoriatic Arthritis in a Placebo- Controlled Trial

Psoriatic Arthritis Response	Percent of Patients	
	Placebo n = 104	etanercept ^a n = 101
ACR 20		
Month 3	15	59 ^b
Month 6	13	50 ^b
ACR 50		
Month 3	4	38 ^b
Month 6	4	37 ^b
ACR 70		
Month 3	0	11 ^b
Month 6	1	9 ^c
PsARC		
Month 3	31	72 ^b
Month 6	23	70 ^b

a: 25 mg etanercept SC twice weekly

b: $p < 0.001$, etanercept vs. placebo

c: $p < 0.01$, etanercept vs. placebo

Among patients with psoriatic arthritis who received etanercept, the clinical responses were apparent at the time of the first visit (4 weeks) and were maintained through 6 months of therapy. Etanercept was significantly better than placebo in all measures of disease activity ($p < 0.001$), and responses were similar with and without concomitant methotrexate therapy. Quality of life in psoriatic arthritis patients was assessed at every timepoint using the disability index of the HAQ. The disability index score was significantly improved at all timepoints in psoriatic arthritis patients treated with etanercept, relative to placebo ($p < 0.001$).

Radiographic changes were assessed in the psoriatic arthritis study. Radiographs of hands and wrists were obtained at baseline and months 6, 12, and 24. The modified TSS at 12 months is presented in the table below. In an analysis in which all patients who dropped out of the study for any reason were considered to have progressed, the percentage of patients without progression (TSS change ≤ 0.5) at 12 months was higher in the etanercept group compared with the placebo group (73% vs. 47%, respectively, $p \leq 0.001$). The effect of etanercept on radiographic progression was maintained in patients who continued on treatment during the second year. The slowing of peripheral joint damage was observed in patients with polyarticular symmetrical joint involvement.

Mean (SE) Annualized Change from Baseline in Total Sharp Score

Time	Placebo (n = 104)	Etanercept (n = 101)
Month 12	1.00 (0.29)	-0.03 (0.09) ^a

SE = standard error.

a. p = 0.0001.

Etanercept treatment resulted in improvement in physical function during the double-blind period, and this benefit was maintained during the longer-term exposure of up to 2 years.

There is insufficient evidence of the efficacy of etanercept in patients with ankylosing spondylitis-like and arthritis mutilans psoriatic arthropathies due to the small number of patients studied.

No study has been performed in patients with psoriatic arthritis using the 50 mg once-weekly dosing regimen. Evidence of efficacy for the once-weekly dosing regimen in this patient population has been based on data from the study in patients with ankylosing spondylitis.

Adult patients with ankylosing spondylitis

The efficacy of etanercept in ankylosing spondylitis was assessed in 3 randomised, double-blind studies comparing twice-weekly administration of 25 mg etanercept with placebo. A total of 401 patients were enrolled, from which 203 were treated with etanercept. The largest of these trials (n=277) enrolled patients who were between 18 and 70 years of age and had active ankylosing spondylitis defined as visual analog scale (VAS) scores of ≥ 30 for average of duration and intensity of morning stiffness plus VAS scores of ≥ 30 for at least 2 of the following 3 parameters: patient global assessment; average of VAS values for nocturnal back pain and total back pain; average of 10 questions on the Bath Ankylosing Spondylitis Functional Index (BASFI). Patients receiving DMARDs, NSAIDs, or corticosteroids could continue them on stable doses. Patients with complete ankylosis of the spine were not included in the study. Doses of 25 mg of etanercept (based on dose-finding studies in patients with rheumatoid arthritis) or placebo were administered subcutaneously twice a week for 6 months in 138 patients.

The primary measure of efficacy (ASAS 20) was a $\geq 20\%$ improvement in at least 3 of the 4 Assessment in Ankylosing Spondylitis (ASAS) domains (patient global assessments, back pain, BASFI, and inflammation) and absence of deterioration in the remaining domain. ASAS 50 and 70 responses used the same criteria with a 50% improvement or a 70% improvement, respectively.

Compared to placebo, treatment with etanercept resulted in significant improvements in the ASAS 20, ASAS 50 and ASAS 70 as early as 2 weeks after the initiation of therapy.

Responses of Patients with Ankylosing Spondylitis in a Placebo-controlled Trial		
	Percent of Patients	
Ankylosing Spondylitis Response	Placebo N = 139	Etanercept N = 138
ASAS 20		
2 weeks	22	46 ^a
3 months	27	60 ^a
6 months	23	58 ^a
ASAS 50		
2 weeks	7	24 ^a
3 months	13	45 ^a
6 months	10	42 ^a
ASAS 70		
2 weeks	2	12 ^b
3 months	7	29 ^b
6 months	5	28 ^b
a: p <0.001, etanercept vs. placebo		
b: p = 0.002, etanercept vs. placebo		

Among patients with ankylosing spondylitis who received etanercept, the clinical responses were apparent at the time of the first visit (2 weeks) and were maintained through 6 months of therapy. Responses were similar in patients who were or were not receiving concomitant therapies at baseline.

Similar results were obtained in the 2 smaller ankylosing spondylitis trials.

In a fourth study, the safety and efficacy of 50 mg etanercept (two 25 mg SC injections) administered once weekly vs. 25 mg etanercept administered twice weekly were evaluated in a double-blind, placebo-controlled study of 356 patients with active ankylosing spondylitis. The safety and efficacy profiles of the 50 mg once-weekly and 25 mg twice-weekly regimens were similar.

Adult patients with non-radiographic axial spondyloarthritis

Study 1

The efficacy of etanercept in patients with non-radiographic axial spondyloarthritis (nr-AxSpa) was assessed in a randomised, 12-week double-blind, placebo-controlled study. The study evaluated 215 adult patients (modified intent-to-treat population) with active nr-AxSpa (18 to 49 years of age), defined as those patients meeting the ASAS classification criteria of axial spondyloarthritis but did not meet the modified New York criteria for AS. Patients were also required to have an inadequate response or intolerance to two or more NSAIDs. In the double-blind period, patients received etanercept 50 mg weekly or placebo for 12 weeks. The primary measure of efficacy (ASAS 40) was a 40% improvement in at least three of the four ASAS domains and absence of deterioration in the remaining domain. The double-blind period was followed by an open-label period during which all patients received etanercept 50 mg weekly for up to an additional 92 weeks. MRIs of the sacroiliac joint and spine were obtained to assess inflammation at baseline and at weeks 12 and 104.

Compared to placebo, treatment with etanercept resulted in statistically significant improvement in the ASAS 40, ASAS 20 and ASAS 5/6. Significant improvement was also observed for the ASAS partial remission and BASDAI 50. Week 12 results are shown in the table below.

Efficacy Response in Placebo-Controlled nr-AxSpa Study: Percent of Patients Achieving Endpoints

Double-Blind Clinical Responses at Week 12	Placebo N=106 to 109*	Etanercept N=103 to 105*
ASAS** 40	15.7	32.4 ^b
ASAS 20	36.1	52.4 ^c
ASAS 5/6	10.4	33.0 ^a
ASAS partial remission	11.9	24.8 ^c
BASDAI***50	23.9	43.8 ^b

*Some patients did not provide complete data for each endpoint

**ASAS=Assessments in Spondyloarthritis International Society

***Bath Ankylosing Spondylitis Disease Activity Index

a: $p < 0.001$, b: < 0.01 and c: < 0.05 , respectively between etanercept and placebo

At week 12, there was a statistically significant improvement in the SPARCC (Spondyloarthritis Research Consortium of Canada) score for the sacroiliac joint (SIJ) as measured by MRI for patients receiving etanercept. Adjusted mean change from baseline was 3.8 for etanercept treated (n=95) versus 0.8 for placebo treated (n=105) patients ($p < 0.001$). At week 104, the mean change from baseline in the SPARCC score measured on MRI for all etanercept-treated subjects was 4.64 for the SIJ (n=153) and 1.40 the spine (n=154).

Etanercept showed statistically significantly greater improvement from baseline to week 12 compared to placebo in most health-related quality of life and physical function assessments, including BASFI (Bath Ankylosing Spondylitis Functional Index), EuroQol 5D Overall Health State Score and SF-36 Physical Component Score.

Clinical responses among nr-AxSpa patients who received etanercept were apparent at the time of the first visit (2 weeks) and were maintained through 2 years of therapy. Improvements in health-related quality of life and physical function were also maintained through 2 years of therapy. The 2 year data did not reveal any new safety findings. At week 104, 8 subjects had progressed to a score of bilateral Grade 2 on spinal X-ray according to the modified New York Radiological Grade, indicative of axial spondyloarthritis.

Study 2

This multi-center, open-label, phase 4, 3-period study evaluated the withdrawal and retreatment of etanercept in patients with active nr-AxSpa who achieved an adequate response (inactive disease defined as Ankylosing Spondylitis Disease Activity Score (ASDAS) C-reactive protein (CRP) less than 1.3) following 24 weeks of treatment.

209 adult patients with active nr-AxSpa (18 to 49 years of age), defined as those patients meeting the Assessment of SpondyloArthritis International Society (ASAS) classification criteria of axial spondyloarthritis (but not meeting the modified New York criteria for AS), having positive MRI findings (active inflammation on MRI highly suggestive of sacroiliitis associated with SpA) and/or positive hsCRP (defined as high sensitivity C-reactive protein [hsCRP] >3 mg/l), and active symptoms defined by an ASDAS CRP greater than or equal to 2.1 at the screening visit received open-label etanercept 50 mg weekly plus stable background NSAID at the optimal tolerated anti inflammatory dosage for 24 weeks in Period 1. Patients were also required to have an inadequate response or intolerance to two or more NSAIDs. At week 24, 119 (57%) patients achieved inactive disease and entered into the Period 2 40-week withdrawal phase where subjects discontinued etanercept, yet maintained the background NSAID. The primary measure of efficacy was the occurrence of flare (defined as an ASDAS erythrocyte sedimentation rate (ESR) greater than or equal to 2.1) within 40 weeks following withdrawal of etanercept. Patients who flared were retreated with etanercept 50 mg weekly for 12 weeks (Period 3).

In Period 2, the proportion of patients experiencing ≥ 1 flare increased from 22% (25/112) at week 4 to 67% (77/115) at week 40. Overall, 75% (86/115) patients experienced a flare at any time point within 40 weeks following withdrawal of etanercept.

The key secondary objective of Study 2 was to estimate time to flare after withdrawal of etanercept and additionally compare the time to flare to patients from Study 1 who met the Study 2 withdrawal phase entry requirements and continued etanercept therapy.

The median time to flare following withdrawal of etanercept was 16 weeks (95% CI: 13-24 weeks). Less than 25% of patients in Study 1 who did not have treatment withdrawn experienced a flare over the equivalent 40-weeks as in Period 2 Study 2. The time to flare was statistically significantly shorter in subjects who discontinued etanercept treatment (Study 2) compared to subjects who received continuous etanercept treatment (Study 1), $p < 0.0001$.

Of the 87 patients who entered Period 3 and were retreated with etanercept 50 mg weekly for 12 weeks, 62% (54/87) re-achieved inactive disease, with 50% of them re-achieving it within 5 weeks (95% CI: 4-8 weeks).

Adult patients with plaque psoriasis

Etanercept is recommended for use in patients as defined in section 4.1. Patients who “failed to respond to” in the target population is defined by insufficient response (PASI<50 or PGA less than good), or worsening of the disease while on treatment, and who were adequately dosed for a sufficiently long duration to assess response with at least each of the three major systemic therapies as available.

The efficacy of etanercept versus other systemic therapies in patients with moderate to severe psoriasis (responsive to other systemic therapies) has not been evaluated in studies directly comparing etanercept with other systemic therapies. Instead, the safety and efficacy of etanercept were assessed in four randomised, double-blind, placebo-controlled studies. The primary efficacy endpoint in all four studies was the proportion of patients in each treatment group who achieved the PASI 75 (i.e., at least a 75% improvement in the Psoriasis Area and Severity Index score from baseline) at 12 weeks.

Study 1 was a Phase 2 study in patients with active, but clinically stable, plaque psoriasis involving $\geq 10\%$ of the body surface area who were ≥ 18 years old. One hundred and twelve (112) patients were randomised to receive a dose of 25 mg of etanercept (n=57) or placebo (n=55) twice a week for 24 weeks.

Study 2 evaluated 652 patients with chronic plaque psoriasis using the same inclusion criteria as study 1 with the addition of a minimum psoriasis area and severity index (PASI) of 10 at screening. Etanercept was administered at doses of 25 mg once a week, 25 mg twice a week or 50 mg twice a week for 6 consecutive months. During the first 12 weeks of the double-blind treatment period, patients received placebo or one of the above three etanercept doses. After 12 weeks of treatment, patients in the placebo group began treatment with blinded etanercept (25 mg twice a week); patients in the active treatment groups continued to week 24 on the dose to which they were originally randomised.

Study 3 evaluated 583 patients and had the same inclusion criteria as study 2. Patients in this study received a dose of 25 mg or 50 mg etanercept, or placebo twice a week for 12 weeks and then all patients received open-label 25 mg etanercept twice weekly for an additional 24 weeks.

Study 4 evaluated 142 patients and had similar inclusion criteria to studies 2 and 3. Patients in this study received a dose of 50 mg etanercept or placebo once weekly for 12 weeks and then all patients received open-label 50 mg etanercept once weekly for an additional 12 weeks.

In study 1, the etanercept-treated group had a significantly higher proportion of patients with a PASI 75 response at week 12 (30%) compared to the placebo-treated group (2%) ($p < 0.0001$). At 24 weeks, 56% of patients in the etanercept-treated group had achieved the PASI 75 compared to 5% of placebo-treated patients. Key results of studies 2, 3 and 4 are shown below.

Responses of Patients with Psoriasis in Studies 2, 3 and 4

Response (%)	-----Study 2-----				-----Study 3-----			-----Study 4-----			
	Placebo n = 166 wk 12	----- etanercept -----				Placebo n = 193 wk 12	--- etanercept ---		Placebo n = 46 wk 12	--- etanercept ---	
		25 mg BIW n = 162 wk 12	50 mg BIW n = 162 wk 24 ^a	25 mg BIW n = 196 wk 12	50 mg BIW n = 196 wk 12		50 mg QW n = 96 wk 12	50 mg QW n = 90 wk 24 ^a			
PASI 50	14	58*	70	74*	77	9	64*	77*	9	69*	83
PASI 75	4	34*	44	49*	59	3	34*	49*	2	38*	71
DSGA ^b , clear or almost clear	5	34*	39	49*	55	4	39*	57*	4	39*	64

* $p \leq 0.0001$ compared with placebo

a. No statistical comparisons to placebo were made at week 24 in studies 2 and 4 because the original placebo group began receiving etanercept 25 mg BIW or 50 mg once weekly from week 13 to week 24.

b. Dermatologist Static Global Assessment. Clear or almost clear defined as 0 or 1 on a 0 to 5 scale.

Among patients with plaque psoriasis who received etanercept, significant responses relative to placebo were apparent at the time of the first visit (2 weeks) and were maintained through 24 weeks of therapy.

Study 2 also had a drug withdrawal period during which patients who achieved a PASI improvement of at least 50% at week 24 had treatment stopped. Patients were observed off treatment for the occurrence of rebound (PASI \geq 150% of baseline) and for the time to relapse (defined as a loss of at least half of the improvement achieved between baseline and week 24). During the withdrawal period, symptoms of psoriasis gradually returned, with a median time to disease relapse of 3 months. No rebound flare of disease and no psoriasis-related serious adverse events were observed. There was some evidence to support a benefit of re-treatment with etanercept in patients initially responding to treatment.

In study 3, the majority of patients (77%) who were initially randomised to 50 mg twice weekly and had their etanercept dose decreased at week 12 to 25 mg twice weekly maintained their PASI 75 response through week 36. For patients who received 25 mg twice weekly throughout the study, the PASI 75 response continued to improve between weeks 12 and 36.

In study 4, the etanercept-treated group had a higher proportion of patients with PASI 75 at week 12 (38%) compared to the placebo-treated group (2%) ($p < 0.0001$). For patients who received 50 mg once weekly throughout the study, the efficacy responses continued to improve with 71% achieving PASI 75 at week 24.

In long-term (up to 34 months) open-label studies where etanercept was given without interruption, clinical responses were sustained and safety was comparable to shorter-term studies.

An analysis of clinical trial data did not reveal any baseline disease characteristics that would assist clinicians in selecting the most appropriate dosing option (intermittent or continuous). Consequently, the choice of intermittent or continuous therapy should be based upon physician judgment and individual patient needs.

Antibodies to etanercept

Antibodies to etanercept have been detected in the sera of some subjects treated with etanercept. These antibodies have all been non-neutralising and are generally transient. There appears to be no correlation between antibody development and clinical response or adverse events.

In subjects treated with approved doses of etanercept in clinical trials for up to 12 months, cumulative rates of anti-etanercept antibodies were approximately 6% of subjects with rheumatoid arthritis, 7.5% of subjects with psoriatic arthritis, 2% of subjects with ankylosing spondylitis, 7% of subjects with psoriasis, 9.7% of subjects with paediatric psoriasis, and 4.8% of subjects with juvenile idiopathic arthritis.

The proportion of subjects who developed antibodies to etanercept in longer-term trials (of up to 3.5 years) increases over time, as expected. However, due to their transient nature, the incidence of antibodies detected at each assessment point was typically less than 7% in rheumatoid arthritis subjects and psoriasis subjects.

In a long-term psoriasis study in which patients received 50 mg twice weekly for 96 weeks, the incidence of antibodies observed at each assessment point was up to approximately 9%.

Paediatric population

Paediatric patients with juvenile idiopathic arthritis

The safety and efficacy of etanercept were assessed in a two-part study in 69 children with polyarticular-course juvenile idiopathic arthritis who had a variety of juvenile idiopathic arthritis onset types (polyarthritis, pauciartthritis, systemic onset). Patients aged 4 to 17 years with moderately to severely active polyarticular-course juvenile idiopathic arthritis refractory to, or intolerant of, methotrexate were enrolled; patients remained on a stable dose of a single non-steroidal anti-inflammatory drug and/or prednisone (< 0.2 mg/kg/day or 10 mg maximum). In part 1, all patients received 0.4 mg/kg (maximum 25 mg per dose) etanercept subcutaneously twice weekly. In part 2, patients with a clinical response at day 90 were randomised to remain on etanercept or receive placebo for four months and assessed for disease flare. Responses were measured using the ACR Pedi 30, defined as $\geq 30\%$ improvement in at least three of six and $\geq 30\%$ worsening in no more than one of six JRA core set criteria, including active joint count, limitation of motion, physician and patient/parent global assessments, functional assessment, and erythrocyte sedimentation rate (ESR). Disease flare was defined as a $\geq 30\%$ worsening in three of six JRA core set criteria and $\geq 30\%$ improvement in not more than one of the six JRA core set criteria and a minimum of two active joints.

In part 1 of the study, 51 of 69 (74%) patients demonstrated a clinical response and entered part 2. In part 2, 6 of 25 (24%) patients remaining on etanercept experienced a disease flare compared to 20 of 26 (77%) patients receiving placebo ($p=0.007$). From the start of part 2, the median time to flare was ≥ 116 days for patients who received etanercept and 28 days for patients who received placebo. Of patients who demonstrated a clinical response at 90 days and entered part 2 of the study, some of the patients remaining on etanercept continued to improve from month 3 through month 7, while those who received placebo did not improve.

In an open-label, safety extension study, 58 paediatric patients from the above study (from the age of 4 years at time of enrolment) continued to receive etanercept for up to 10 years. Rates of serious adverse events and serious infections did not increase with long-term exposure.

Long-term safety of etanercept monotherapy ($n=103$), etanercept plus methotrexate ($n=294$), or methotrexate monotherapy ($n=197$) were assessed for up to 3 years in a registry of 594 children aged 2 to 18 years with juvenile idiopathic arthritis, 39 of whom were 2 to 3 years of age. Overall, infections were more commonly reported in patients treated with etanercept compared to methotrexate alone (3.8 versus 2%), and the infections associated with etanercept use were of a more severe nature.

In another open-label single-arm study ($n=127$), 60 patients with extended oligoarthritis (EO) (15 patients aged 2 to 4, 23 patients aged 5 to 11 and 22 patients aged 12 to 17 years old), 38 patients with enthesitis-related arthritis (12 to 17 years old), and 29 patients with psoriatic arthritis (12 to 17 years old) were treated with etanercept at a dose of 0.8 mg/kg (up to a

maximum of 50 mg per dose) administered weekly for 12 weeks. In each of the JIA subtypes, the majority of patients met ACR Pedi 30 criteria and demonstrated clinical improvement in secondary endpoints such as number of tender joints and physician global assessment. The safety profile was consistent with that observed in other JIA studies.

Of the 127 patients in the parent study, 109 participated in the open-label extension study and were followed for 8 years. At the end of the extension study, 84/109 (77%) patients had completed the study; 27 (25%) while actively taking etanercept, 7 (6%) had withdrawn from treatment due to low/inactive disease; 5 (5%) had re-started etanercept following an earlier withdrawal from treatment; and 45 (41%) had stopped etanercept (but remained under observation); 25/109 (23%) patients permanently discontinued from the study. Improvements in clinical status achieved in the parent study were generally maintained for all efficacy endpoints during the entire follow-up period. Patients actively taking etanercept could enter an optional withdrawal-retreatment period once during the extension study based on investigator's judgement of clinical response. 30 patients entered the withdrawal period. 17 patients were reported to have a flare (defined as $\geq 30\%$ worsening in at least 3 of the 6 ACR Pedi components with $\geq 30\%$ improvement in not more than 1 of the remaining 6 components and a minimum of 2 active joints); median time to flare after etanercept withdrawal was 190 days. 13 patients were re-treated and the median time to re-treatment from withdrawal was estimated as 274 days. Due to the small number of data points, these results should be interpreted with caution.

The safety profile was consistent with that observed in the parent study.

Studies have not been done in patients with juvenile idiopathic arthritis to assess the effects of continued etanercept therapy in patients who do not respond within 3 months of initiating etanercept therapy. Additionally, studies have not been conducted to assess reducing the recommended dose of etanercept following its long-term use in patients with JIA.

Paediatric patients with plaque psoriasis

The efficacy of etanercept was assessed in a randomised, double-blind, placebo-controlled study in 211 paediatric patients aged 4 to 17 years with moderate to severe plaque psoriasis (as defined by an sPGA score ≥ 3 , involving $\geq 10\%$ of the BSA, and PASI ≥ 12). Eligible patients had a history of receiving phototherapy or systemic therapy, or were inadequately controlled on topical therapy.

Patients received etanercept 0.8 mg/kg (up to 50 mg) or placebo once weekly for 12 weeks. At week 12, more patients randomised to etanercept had positive efficacy responses (e.g., PASI 75) than those randomised to placebo.

Paediatric Plaque Psoriasis Outcomes at 12 Weeks

	Etanercept 0.8 mg/kg Once Weekly (N = 106)	Placebo (N = 105)
PASI 75, n (%)	60 (57%) ^a	12 (11%)
PASI 50, n (%)	79 (75%) ^a	24 (23%)
sPGA “clear” or “minimal”, n (%)	56 (53%) ^a	14 (13%)

Abbreviation: sPGA-static Physician Global Assessment

a. $p < 0.0001$ compared with placebo

After the 12-week double-blind treatment period, all patients received etanercept 0.8 mg/kg (up to 50 mg) once weekly for additional 24 weeks. Responses observed during the open-label period were similar to those observed in the double-blind period.

During a randomised withdrawal period, significantly more patients re-randomised to placebo experienced disease relapse (loss of PASI 75 response) compared with patients re-randomised to etanercept. With continued therapy, responses were maintained up to 48 weeks.

The long-term safety and effectiveness of etanercept 0.8 mg/kg (up to 50 mg) once weekly was assessed in an open-label extension study of 181 paediatric subjects with plaque psoriasis for up to 2 years beyond the 48 week study discussed above. Long-term experience with etanercept was generally comparable to the original 48-week study and did not reveal any new safety findings.

5.2 Pharmacokinetic properties

Etanercept serum values were determined by an Enzyme-Linked Immunosorbent Assay (ELISA) method, which may detect ELISA-reactive degradation products, as well as the parent compound.

Absorption

Etanercept is slowly absorbed from the site of subcutaneous injection, reaching maximum concentration approximately 48 hours after a single dose. The absolute bioavailability is 76%. With twice-weekly doses, it is anticipated that steady-state concentrations are approximately twice as high as those observed after single doses. After a single subcutaneous dose of 25 mg etanercept, the average maximum serum concentration observed in healthy volunteers was 1.65 ± 0.66 $\mu\text{g/ml}$, and the area under the curve was 235 ± 96.6 $\mu\text{g}\cdot\text{hr/ml}$.

Mean serum concentration profiles at steady state in treated RA patients were C_{max} of 2.4 mg/l vs. 2.6 mg/l, C_{min} of 1.2 mg/l vs. 1.4 mg/l, and partial AUC of 297 mg•h/l vs. 316 mg•h/l for 50 mg etanercept once weekly (n=21) vs. 25 mg etanercept twice weekly (n=16), respectively. In an open-label, single-dose, two-treatment, crossover study in healthy volunteers, etanercept

administered as a single 50 mg/ml injection was found to be bioequivalent to two simultaneous injections of 25 mg/ml.

In a population pharmacokinetics analysis in ankylosing spondylitis patients, the etanercept steady state AUCs were 466 $\mu\text{g}\cdot\text{hr}/\text{ml}$ and 474 $\mu\text{g}\cdot\text{hr}/\text{ml}$ for 50 mg etanercept once weekly (N = 154) and 25 mg twice weekly (N = 148), respectively.

Distribution

A biexponential curve is required to describe the concentration time curve of etanercept. The central volume of distribution of etanercept is 7.6 l, while the volume of distribution at steady-state is 10.4 l.

Elimination

Etanercept is cleared slowly from the body. The half-life is long, approximately 70 hours. Clearance is approximately 0.066 l/hr in patients with rheumatoid arthritis, somewhat lower than the value of 0.11 l/hr observed in healthy volunteers. Additionally, the pharmacokinetics of etanercept in rheumatoid arthritis patients, ankylosing spondylitis and plaque psoriasis patients are similar.

There is no apparent pharmacokinetic difference between males and females.

Linearity

Dose proportionality has not been formally evaluated, but there is no apparent saturation of clearance across the dosing range.

Special populations

Renal impairment

Although there is elimination of radioactivity in urine after administration of radiolabelled etanercept to patients and volunteers, increased etanercept concentrations were not observed in patients with acute renal failure. The presence of renal impairment should not require a change in dosage.

Hepatic impairment

Increased etanercept concentrations were not observed in patients with acute hepatic failure. The presence of hepatic impairment should not require a change in dosage.

Elderly

The impact of advanced age was studied in the population pharmacokinetic analysis of etanercept serum concentrations. Clearance and volume estimates in patients aged 65 to 87 years were similar to estimates in patients less than 65 years of age.

Paediatric population

Paediatric patients with juvenile idiopathic arthritis

In a polyarticular-course juvenile idiopathic arthritis trial with etanercept, 69 patients (aged 4 to 17 years) were administered 0.4 mg etanercept/kg twice weekly for three months. Serum concentration profiles were similar to those seen in adult rheumatoid arthritis patients. The youngest children (4 years of age) had reduced clearance (increased clearance when normalised by weight) compared with older children (12 years of age) and adults. Simulation of dosing suggests that while older children (10-17 years of age) will have serum levels close to those seen in adults, younger children will have appreciably lower levels.

Paediatric patients with plaque psoriasis

Patients with paediatric plaque psoriasis (aged 4 to 17 years) were administered 0.8 mg/kg (up to a maximum dose of 50 mg per week) of etanercept once weekly for up to 48 weeks. The mean serum steady-state trough concentrations ranged from 1.6 to 2.1 mcg/ml at weeks 12, 24, and 48. These mean concentrations in patients with paediatric plaque psoriasis were similar to the concentrations observed in patients with juvenile idiopathic arthritis (treated with 0.4 mg/kg etanercept twice weekly, up to maximum dose of 50 mg per week). These mean concentrations were similar to those seen in adult patients with plaque psoriasis treated with 25 mg etanercept twice-weekly.

5.3 Preclinical safety data

In the toxicological studies with etanercept, no dose-limiting or target organ toxicity was evident. Etanercept was considered to be non-genotoxic from a battery of *in vitro* and *in vivo* studies.

Carcinogenicity studies, and standard assessments of fertility and postnatal toxicity, were not performed with etanercept due to the development of neutralising antibodies in rodents.

Etanercept did not induce lethality or notable signs of toxicity in mice or rats following a single subcutaneous dose of 2,000 mg/kg or a single intravenous dose of 1,000 mg/kg. Etanercept did not elicit dose-limiting or target organ toxicity in cynomolgus monkeys following twice weekly subcutaneous administration for 4 or 26 consecutive weeks at a dose (15 mg/kg) that resulted in AUC-based serum drug concentrations that were over 27-fold higher than that obtained in humans at the recommended dose of 25 mg.

6. PHARMACEUTICAL PARTICULARS

6.1 List of excipients

Sodium citrate dihydrate
Sucrose
L-Lysine hydrochloride
Sodium chloride
Citric acid anhydrous
Sodium hydroxide
Hydrochloric acid
Water for injection

6.2 Incompatibilities

In the absence of compatibility studies, this medicinal product must not be mixed with other medicinal products.

6.3 Shelf life

The expiry date of the product is indicated on the packaging materials.

6.4 Special precautions for storage

Store in a refrigerator (2°C - 8°C). Do not freeze. Keep in the outer carton in order to protect from light.

After taking a syringe from the refrigerator, wait approximately 15-30 minutes to

allow the Erelzi solution in the syringe to reach room temperature. Do not warm in any other way. Immediate use is then recommended.

Erelzi may be stored at temperatures up to a maximum of 25°C for a single period of up to four weeks; after which it should not be refrigerated again. Erelzi should be discarded if not used within four weeks after removal from the refrigeration.

6.5 Nature and contents of container

Erelzi solution for injection in pre-filled syringe

Clear type I glass syringe with a stainless steel 27 gauge ½ inch needle with a needle guard with finger flange, rubber needle cap and plastic plunger, containing 0.5 ml or 1.0 ml of solution.

Erelzi 50 mg solution for injection in pre-filled pen

Erelzi is supplied in a single-use pre-filled syringe assembled into a triangular-shaped pen with transparent window and label (SensoReady pen). The syringe inside the pen is made from clear type I glass with a stainless steel 27 gauge ½ inch needle and an inner rubber needle cap, containing 1.0 ml of solution.

Cartons contain 1, 2 or 4 pre-filled syringes or pre-filled pens of Erelzi. Multipacks contain 12 (3 packs of 4) 25 mg or 50 mg pre-filled syringes or pre-filled pens or 8 (2 packs of 4) or 24 (6 packs of 4) 25 mg pre-filled syringes of Erelzi. Not all pack sizes may be marketed.

6.6 Special precautions for disposal and other handling

Instructions for use and handling of the Erelzi pre-filled syringe

Before injection, Erelzi single-use pre-filled syringe should be allowed to reach room temperature (approximately 15 to 30 minutes). The needle cap should not be removed while allowing the pre-filled syringe to reach room temperature. The solution should be clear to slightly opalescent, colourless to slightly yellowish and may contain small translucent or white particles of protein.

Comprehensive instructions for administration are given in the package leaflet, section 7, "Instructions for use of the Erelzi pre-filled syringe".

Instructions for use and handling of the Erelzi pre-filled SensoReady pen

Before injection, Erelzi single-use pre-filled pens should be allowed to reach room temperature (approximately 15 to 30 minutes). The needle cap should not be removed while allowing the pre-filled pen to reach room temperature. By looking through the viewing window, the solution should be clear to slightly opalescent, colourless to slightly yellowish and may contain small translucent or white particles of protein.

Comprehensive instructions for administration are given in the package leaflet, section 7, "Instructions for use of the Erelzi SensoReady pen".

Any unused medicinal product or waste material should be disposed of in accordance with local requirements.

7. Instructions for preparing and administration of Erelzi injection

7.1 Instructions for use of Erelzi pre-filled syringe

It is important not to try to inject yourself until you have been trained by your doctor, nurse or pharmacist. The box contains Erelzi pre-filled syringe(s) individually sealed in a plastic blister.

DO NOT USE

In this configuration the needle guard is **ACTIVATED** – **DO NOT USE** the pre-filled syringe

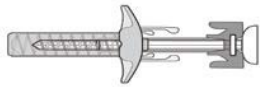

READY TO BE USED

In this configuration the needle guard is **NOT ACTIVATED** and the pre-filled syringe is ready for use

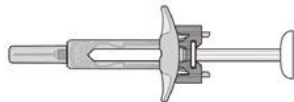

Your Erelzi pre-filled syringe with needle guard and add-on finger flange

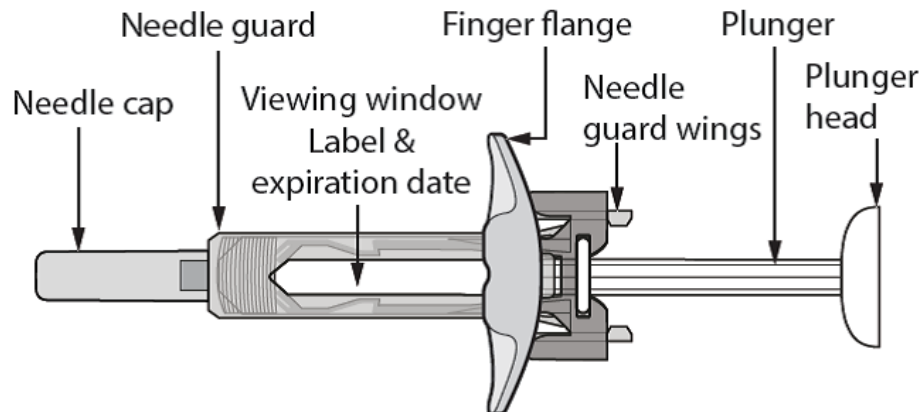

After the medicine has been injected, the needle guard will be activated to cover the needle. This is intended to aid in the protection of healthcare professionals, patients who self-inject doctor-prescribed medicines and individuals who assist self-injecting patients from accidental needle stick injuries.

What you additionally need for your injection:

- Alcohol wipe
- Cotton ball or gauze
- Sharps disposal container



Important safety information

Caution: Keep the syringe out of the sight and reach of children.

1. Do not open the outer box until you are ready to use this medicine.
2. Do not use this medicine if the seal of the blister is broken, as it may not be safe for you to use.
3. Do not shake the syringe.
4. Never leave the syringe lying around where others might tamper with it.
5. The pre-filled syringe has a needle guard that will be activated to cover the needle after the injection is finished. The needle guard will help to prevent needle stick injuries to anyone who handles the pre-filled syringe.
6. Be careful not to touch the needle guard wings before use. By touching them, the needle guard may be activated too early.
7. Do not remove the needle cap until just before you give the injection.
8. The syringe cannot be re-used. Dispose of the used syringe immediately after use in a sharps container.

Storage of the Erelzi pre-filled syringe

1. Store this medicine sealed in its outer box to protect it from light. Store in the refrigerator between 2 °C to 8 °C. **DO NOT FREEZE.**
2. Remember to take the blister out of the refrigerator and allow it to reach room temperature before preparing it for injection (15–30 minutes).
3. Do not use the syringe after the expiry date which is stated on the outer box or syringe label after “EXP”. If it has expired, return the entire pack to the pharmacy.

The injection site

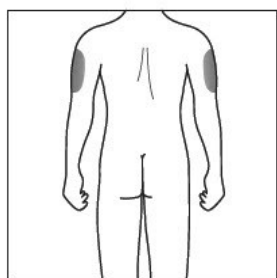
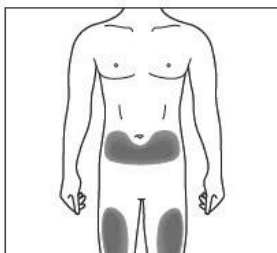

The injection site is the place on the body where you are going to use the pre-filled syringe.

- The recommended site is the front of your thighs. You may also use the lower abdomen, but **not** the area 5 centimeters around the navel (belly button).
- Choose a different site each time you give yourself an injection.
- Do not inject into areas where the skin is tender, bruised, red, scaly or hard. Avoid areas with scars or stretch marks.

If you have psoriasis, you should **NOT** inject directly into any raised, thick, red, or scaly skin patches or lesions (“psoriasis skin lesions”). If a caregiver is giving you the injection, the outer upper arms may also be used.

Preparing the Erelzi pre-filled syringe

1. Take the blister out of the refrigerator and leave it **unopened** for about 15–30 minutes so that it reaches room temperature.
2. When you are ready to use the syringe, open the blister and wash your hands thoroughly with soap and water.
3. Clean the injection site with an alcohol swab.
4. Take the syringe out of the blister.
5. Inspect the syringe. The liquid should be clear or slightly opalescent, colourless to slightly yellowish, and may contain small white or almost translucent particles of protein. This appearance is normal for Erelzi. Do not use if the liquid is cloudy, discoloured, or has large lumps, flakes, or coloured particles. Do not use if the syringe is broken or the needle guard is activated. In all these cases, return the entire product pack to the pharmacy.

How to use the Erelzi pre-filled syringe

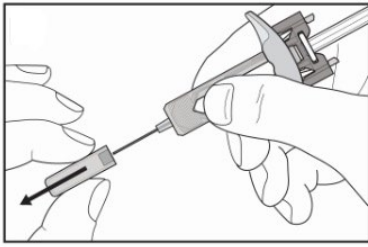

Carefully remove the needle cap from the syringe. Discard the needle cap. You may see a drop of liquid at the end of the needle. This is normal.

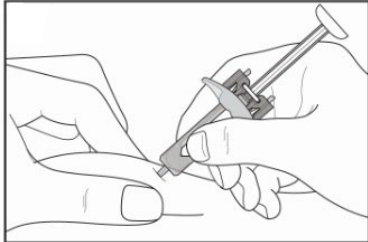

Gently pinch the skin at the injection site and insert the needle as shown. Push the needle all the way in to ensure that the medicine can be fully administered.

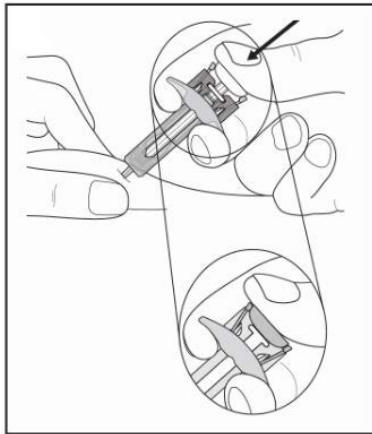

Hold the syringe finger flange as shown. **Slowly** press the plunger **as far as it will go**, so that the plunger head is completely between the needle guard wings. Keep the plunger pressed fully down while you hold the syringe in place for 5 seconds.

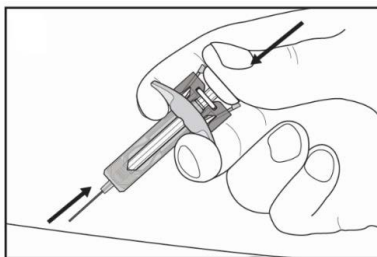

Keep the plunger fully depressed while you carefully lift the needle straight out from the injection site.

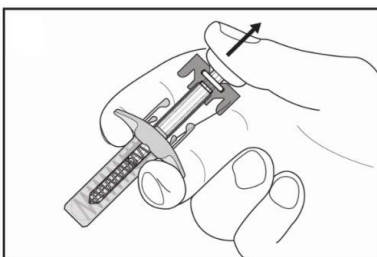

Slowly release the plunger and allow the needle guard to automatically cover the exposed needle. There may be a small amount of blood at the injection site. You can press a cotton ball or gauze over the injection site and hold it for 10 seconds. Do not rub the injection site. You may cover the injection site with a small adhesive bandage, if needed.

Disposal instructions

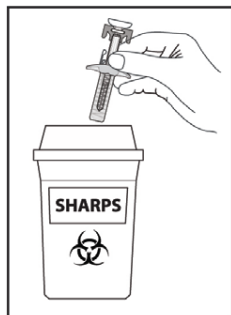

Dispose of the used syringe in a sharps container (closable, puncture-resistant container). For the safety and health of you and others, needles and used syringes **must never** be re-used.

If you have any questions, please talk to a doctor, nurse or pharmacist who is familiar with Erelzi.

7.2 Instructions for use of Erelzi SensoReady pen



Read ALL the way through these instructions before injecting.

These instructions are to help you to inject correctly using the Erelzi SensoReady pen. It is important not to try to inject yourself until you have been trained by your doctor, nurse or pharmacist.

Your Erelzi SensoReady pen:

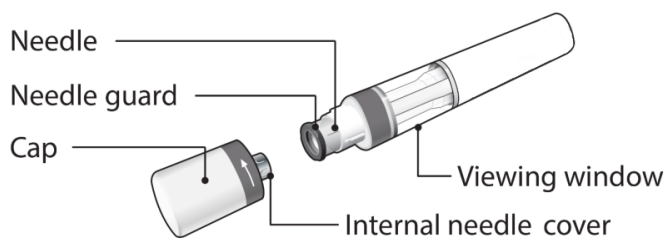

Erelzi SensoReady pen shown with the cap removed.
Do not remove the cap until you are ready to inject.

Store your boxed pen in a **refrigerator**, between 2 °C to 8 °C and **out of the sight and reach of children**.

- **Do not freeze** the pen.
- **Do not shake** the pen.
- Do not use the pen if it has been **dropped** with the cap removed. For a more comfortable injection, take the pen out of the refrigerator **15-30 minutes before injecting** to allow it to reach

room temperature.

What you need for your injection:

Included in the carton:

A new and unused Erelzi SensoReady pen.

Not included in the carton:

- Alcohol wipe
- Cotton ball or gauze
- Sharps disposal container

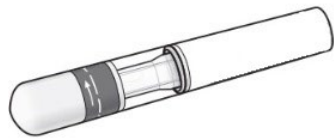

Before your injection:

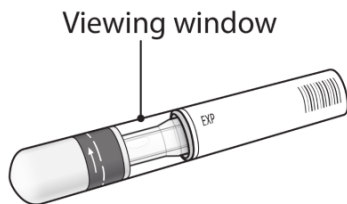

1. Important safety checks before you inject:

The solution should be clear or slightly opalescent, colourless to slightly yellowish, and may contain small white or almost translucent particles of protein. This appearance is normal for Erelzi.

Do not use if the liquid is cloudy, discoloured, or has large lumps, flakes, or coloured particles.

Do not use the pen if the **expiry date** has passed.

Do not use if the **safety seal** has been broken.

Contact your pharmacist if the pen fails any of these checks.

2a. Choose your injection site:

- The recommended site is the front of the thighs. You may also use the lower abdomen, but **not** the area 5 centimetres around the navel (belly button).
- Choose a different site each time you give yourself an injection.
- Do not inject into areas where the skin is tender, bruised, red, scaly or hard. Avoid areas with scars or stretch marks. If you have psoriasis, you should **NOT** inject directly into any raised, thick, red, or scaly skin patches or lesions (“psoriasis skin lesions”).

2b. Caregivers and healthcare professionals only:

- If a **caregiver** or **healthcare professional** is giving you your injection, they may also inject into your outer upper arm.

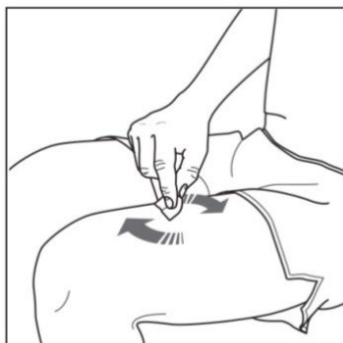
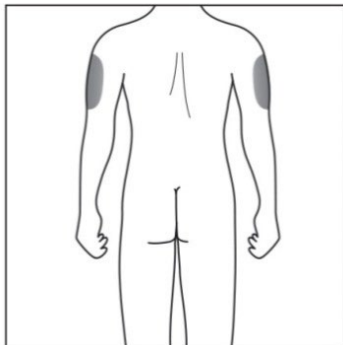
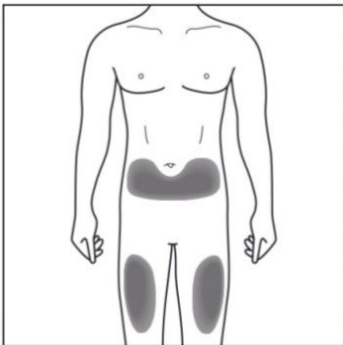

3. Cleaning your injection site:

- Wash your hands with soap and hot water.
- Using a circular motion, clean the injection site with the alcohol swab. Leave it to dry before injecting.
- Do not touch the cleaned area again before injecting.

Your injection:

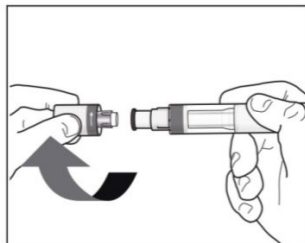

4. Removing the cap:

- Only remove the cap when you are ready to use the pen.
- Twist off the cap in the direction of the arrows.
- Once removed, throw away the cap. **Do not try to re-attach the cap.**
- Use the pen within 5 minutes of removing the cap.

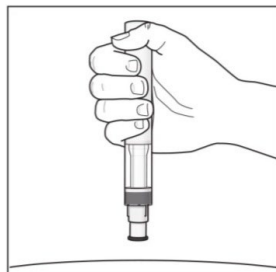

5. Holding your pen:

- Hold the pen at 90 degrees to the cleaned injection site



Correct



Incorrect



YOU MUST READ THIS BEFORE INJECTING.

During the injection you will hear **2 loud clicks**.

The **1st click** indicates that the injection has started. Several seconds later a **2nd click** will indicate that the injection is **almost** finished.

You must keep holding the pen firmly against your skin until you see a **green indicator** fill the window and stop moving.

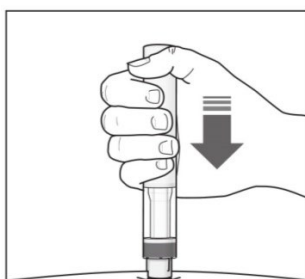

6. Starting your injection:

- Press the pen firmly against the skin to start the injection.
- The **1st click** indicates the injection has started.
- **Keep holding** the pen firmly against your skin.
- The **green indicator** shows the progress of the injection.

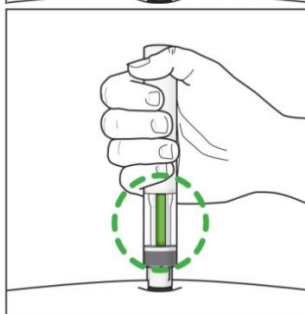

7. Completing your injection:

- Listen for the **2nd click**. This indicates the injection is **almost** complete.
- Check the **green indicator** fills the window and has stopped moving.
- The pen can now be removed.

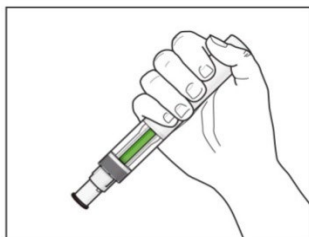

After your injection:

8. Check the green indicator fills the window:

- This means the medicine has been delivered. Contact your doctor if the green indicator is not visible.
- There may be a small amount of blood at the injection site. You can press a cotton ball or gauze over the injection site and hold it for 10 seconds. Do not rub the injection site. You may cover the injection site with a small adhesive bandage, if needed.

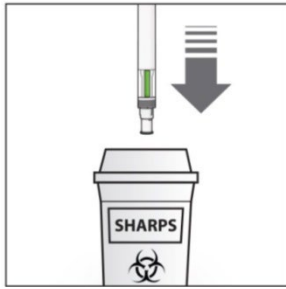

9. Disposing of your Erelzi pen:

- Dispose of the used pen in a sharps disposal container (i.e. a puncture-resistant closable container, or similar).
- Never try to re-use your pen.

If you have any questions, please talk to a doctor, nurse or pharmacist who is familiar with Erelzi.

8. MANUFACTURER

Sandoz GmbH Schafftenau, Biochemiestrasse 10, 6336 Langkampfen, Austria

9. LICENSE HOLDER

Novartis Israel Ltd., P.O.Box 7126, Tel Aviv

10. REGISTRATION NUMBERS

Erelzi[®] 25: 163-20-36011-00

Erelzi[®] 50: 163-21-36037-00

Revised in November 2022 according to MOH guidelines

ERE API NOV2022 V1