

Patient leaflet in accordance with the Pharmacists' Regulations (Preparations) – 1986

The medicine is dispensed according to a doctor's prescription only

AMGEVITA[®], solution for subcutaneous injection

Adalimumab 50 mg/mL

Amgevita 20 mg solution for injection in pre-filled syringe

Each single dose pre-filled syringe contains 20 mg of adalimumab in 0.4 mL (50 mg/mL) solution.

Amgevita 40 mg solution for injection in pre-filled syringe

Each single dose pre-filled syringe contains 40 mg of adalimumab in 0.8 mL (50 mg/mL) solution.

Amgevita 40 mg solution for injection in pre-filled pen

Each single dose pre-filled pen contains 40 mg of adalimumab in 0.8 mL (50 mg/mL) solution.

For inactive ingredients and allergens in the product - see section 6 "additional information".

Read the entire leaflet carefully before using the medicine. This leaflet contains concise information about the medicine. If you have any other questions, refer to the doctor or the pharmacist.

This medicine has been prescribed for you. Do not pass it on to others. It may harm them even if it seems to you that their medical condition is similar.

In addition to the leaflet, **Amgevita** has a 'Patient safety information card'. This card includes important safety information, which you should know before starting and during the treatment with **Amgevita** and act accordingly. Read the 'Patient safety information card' and the patient leaflet before starting treatment with the medicine. Keep the card for further reference if needed.

AMGEVITA is a biosimilar medicinal product. For further information regarding biosimilar products refer to the Israeli ministry of health website:

<https://www.health.gov.il/UnitsOffice/HD/MTI/Drugs/Registration/Pages/Biosimilars.aspx>

For your attention, it is important that you make sure you receive the same medicine prescribed to you by your specialist attending physician each time you receive the medicine at the pharmacy. If the medicine you received looks different than the one you are usually getting or the instructions for use had changed, please turn immediately to the pharmacist to make sure you received the correct medicine. Each replacement or change of dosage of a medicine containing adalimumab must be done only by the specialist attending physician. Please check that the commercial name of the medicinal product prescribed to you by your specialist physician, is identical to the name of the medicine received from the pharmacist.

1. What is the medicine intended for?

Amgevita is intended for the treatment of:

- Moderate to severe, active rheumatoid arthritis in adults, when other accepted treatment has been inadequate.
- Severe, active and progressive rheumatoid arthritis in adults not previously treated with methotrexate.
- Severe active ankylosing spondylitis in adults, when other accepted treatment has been inadequate.
- Severe axial spondyloarthritis without radiographic evidence of ankylosing spondylitis in adults when there was an inadequate response to, or intolerance to, non-steroidal anti-inflammatory drugs (NSAIDs).
- Active and progressive psoriatic arthritis in adults, when other accepted treatment has been inadequate.
- Moderate to severe plaque psoriasis in adults who are candidates for systemic therapy.
- Active moderate to severe hidradenitis suppurativa in adult patients when accepted treatment has been inadequate.
- Moderate to severe active Crohn's disease in adults, when other accepted treatment is either inappropriate or has been inadequate.
- Moderate to severe ulcerative colitis in adults, when other accepted treatment has been inadequate or in patients who can't receive other accepted treatments.
- Uveitis – inflammation of the uvea (panuveitis, posterior or intermediate), from a non-infectious source, in adults, when treatment with steroids is inappropriate or inadequate.
- Intestinal Behcet's disease, when other accepted treatment has been inadequate.

Therapeutic group: Immunosuppressants, Tumor Necrosis Factor alpha (TNF α) inhibitors.

The active ingredient in **Amgevita**, adalimumab, is a human monoclonal antibody. Monoclonal antibodies are proteins that attach to a specific target.

The target of adalimumab is a protein called tumour necrosis factor (TNF α), which is involved in the immune (defence) system and is present at increased levels in the inflammatory diseases listed above. By attaching to TNF α , **Amgevita** decreases the process of inflammation in these diseases.

Amgevita is not intended for children and adolescents under 18 years old.

2. Before using the medicine

X Do not use the medicine if:

- You are sensitive (allergic) to the active ingredient or to any of the additional ingredients included in the medicine (see section 6 "Further Information").
- You have active tuberculosis or other severe infections (see "Special warnings regarding use of the medicine"). It is important that you tell your doctor if you have symptoms of infections, for example: fever, wounds, feeling tired and dental problems.
- You have moderate or severe heart failure. It is important to tell your doctor if you have had or have a serious heart condition (see "Special warnings regarding use of the medicine").

Do not use **Amgevita** if any of the above applies to you. If you are not sure, talk to your doctor or pharmacist before using **Amgevita**.

Special warnings regarding the use of the medicine

Talk to your doctor or pharmacist before using **Amgevita**.

Allergic reactions

- If you get allergic reactions with symptoms such as chest tightness, wheezing, dizziness, swelling or rash, do not inject more **Amgevita**, and contact your doctor immediately since, in rare cases, these reactions can be life-threatening.

Infections

- If you have an infection, including long-term infection or an infection in one part of the body (for example, a leg ulcer), consult your doctor before starting **Amgevita**. If you are unsure, contact your doctor.
- You might get infections more easily while you are receiving **Amgevita** treatment. This risk may increase if you have problems with your lungs. These infections may be serious and include:
 - tuberculosis
 - infections caused by viruses, fungi, parasites or bacteria
 - severe infection in the blood (sepsis)

In rare cases, these infections can be life-threatening. It is important to tell your doctor if you get symptoms such as fever, wounds, feeling tired or dental problems. The doctor may tell you to stop using **Amgevita** for some time.

- Consult your doctor if you live or travel in regions where fungal infections (for example, histoplasmosis, coccidioidomycosis or blastomycosis) are very common.
- Consult your doctor if you have had infections which keep coming back or other conditions that increase the risk of infections.
- If you are over 65 years, you may be more likely to get infections while taking **Amgevita**. You and the doctor should pay special attention to signs of infection while you are being treated with **Amgevita**. It is important to tell the doctor if you get symptoms of infections, such as fever, wounds, feeling tired or dental problems.

Tuberculosis

- It is very important that you tell your doctor if you have ever had tuberculosis, or if you have been in close contact with someone who has had tuberculosis. If you have active tuberculosis, do not use **Amgevita**.
 - As cases of tuberculosis have been reported in patients treated with **Amgevita**, your doctor will check you for signs and symptoms of tuberculosis before starting **Amgevita**. This will include a thorough medical evaluation including your medical history and appropriate screening tests (for example, chest X-ray and a tuberculin test). The conduct and results of these tests should be recorded on your '**Patient safety information card**'.
 - Tuberculosis can develop during treatment with **Amgevita**, even if you have received treatment for the prevention of tuberculosis.
 - If symptoms of tuberculosis (for example, cough that does not go away, weight loss, lack of energy, mild fever), or any other infection appear during or after treatment with **Amgevita**, tell the doctor immediately.

Hepatitis B

- Tell your doctor if you are a carrier of the hepatitis B virus (HBV), if you have active HBV or if you think you might be at risk of getting HBV.
 - Your doctor should test you for HBV. In people who carry HBV, **Amgevita** can cause the virus to become active again.
 - In some rare cases, especially if you are taking other medicines that suppress the immune system, reactivation of HBV can be life-threatening.

Surgery or dental procedure

- If you are about to have surgery or dental procedures, please inform your doctor that you are taking **Amgevita**. Your doctor may recommend temporary discontinuation of **Amgevita**.

Demyelinating diseases

- If you have or develop a demyelinating disease (a disease that affects the insulating layer around the nerves, such as multiple sclerosis), your doctor will decide if you should receive or continue to receive **Amgevita**. Tell the doctor immediately if you experience symptoms like changes in your vision, weakness in your arms or legs or numbness or tingling in any part of your body.

Vaccines

- Certain vaccines may cause infections and should not be given during treatment with **Amgevita**.
 - Consult your doctor before you receive any vaccine.
 - If you received **Amgevita** while you were pregnant, your baby may be at a higher risk for getting an infection for up to approximately five months after the last dose you received during pregnancy. It is important that you tell your baby's doctors and other health-care professionals about your **Amgevita** treatment during pregnancy so that they can decide when your baby may receive vaccinations.

Heart failure

- If you have mild heart failure and are being treated with **Amgevita**, your heart failure status must be closely monitored by your doctor. It is important to tell your doctor if you have had or have a serious heart condition. If you develop new or worsening symptoms of heart failure (e.g., shortness of breath, or swelling of your feet), you must contact the doctor immediately. Your doctor will decide if you should receive **Amgevita**.

Fever, bruising, bleeding or looking pale

- In some patients the body may fail to produce enough of the blood cells that fight off infections or help you to stop bleeding. Your doctor may decide to stop treatment. If you develop a fever that does not go away, develop light bruises or bleed very easily or look very pale, contact the doctor immediately.

Cancer

- There have been very rare cases of certain kinds of cancer in patients taking **Amgevita** or other TNF blockers.
 - People with more serious rheumatoid arthritis that have had the disease for a long time may have a higher than average risk of getting lymphoma (a cancer that affects the lymph system) and leukemia (a cancer that affects the blood and bone marrow).
 - If you take **Amgevita**, the risk of getting lymphoma, leukemia, or other cancers may increase. On rare occasions, an uncommon and severe type of lymphoma has been seen in patients taking **Amgevita**. Some of those patients were also treated with azathioprine or 6-mercaptopurine.
 - Tell your doctor if you are taking azathioprine or 6-mercaptopurine with **Amgevita**.
 - Cases of non-melanoma skin cancer have been observed in patients taking **Amgevita**.
 - If new skin lesions appear during or after treatment with **Amgevita** or if existing lesions change appearance, tell the doctor.
- There have been cases of cancers other than lymphoma in patients with a specific type of lung disease called Chronic Obstructive Pulmonary Disease (COPD) treated with another TNF blocker. If you have COPD, or are a heavy smoker, you should discuss with your doctor whether treatment with a TNF blocker is appropriate for you.

Autoimmune disease

- On rare occasions, treatment with **Amgevita** could result in lupus-like syndrome. Contact your doctor if symptoms such as persistent unexplained rash, fever, joint pain or tiredness occur.

! Other medicines and Amgevita

If you are taking, or have recently taken, other medicines including non-prescription medicines and food supplements, tell the doctor or the pharmacist.

Do not take **Amgevita** with medicines containing the following active ingredients due to increased risk of serious infection:

- anakinra
- abatacept

These medicines are used for the treatment of rheumatoid arthritis.

Amgevita can be taken together with:

- methotrexate
- certain disease-modifying anti-rheumatic agents (for example, sulfasalazine, hydroxychloroquine, leflunomide and injectable gold preparations)
- steroids or analgesics, including non-steroidal anti-inflammatory drugs (NSAIDs).

If you have questions, ask the doctor.

! Pregnancy, breast-feeding and fertility

- You should consider the use of adequate contraception to prevent pregnancy and continue its use for at least 5 months after the last **Amgevita** treatment.
- If you are pregnant, think you may be pregnant or are planning to have a baby, ask your doctor for advice about taking this medicine.
- **Amgevita** should only be used during a pregnancy if needed.
- In a study for use in women during pregnancy, there was no higher risk of birth defects when the mother had received **Amgevita** during pregnancy compared with mothers with the same disease who did not receive **Amgevita**.
- **Amgevita** can be used while breast-feeding.
- If you received **Amgevita** during your pregnancy, your baby may have a higher risk for getting an infection.
- It is important that you tell your baby's doctors and other health-care professionals in the clinic and in the Family Health Center (Tipat-Halav) about your **Amgevita** use during your pregnancy before the baby receives any vaccine. For more information on vaccines see the "Special warnings regarding the use of the medicine" section.

! Driving and using machines

Amgevita may have a minor effect on the ability to drive, cycle or operate machines. After treatment with **Amgevita**, dizziness and vision disturbances may occur.

! Smoking

If you are a heavy smoker, you should consult the attending doctor as to whether treatment with a TNF blocker is appropriate for you (for further information, see "Special warnings regarding use of the medicine" section).

Important information about some ingredients of the medicine

Amgevita contains sodium

This medicine contains less than 1 mmol of sodium (23 mg) per dose, i.e. essentially 'sodium-free'.

3. How to use Amgevita

Always use this medicine according to the doctor's instructions.

Check with the doctor or pharmacist if you are not sure about the dosage and treatment regimen.

The dosage and treatment regimen will be determined by the attending doctor only.

Do not exceed the recommended dose.

Method and route of administration

Amgevita is administered using a pre-filled pen / syringe by injection under the skin (subcutaneous injection).

Detailed instructions on how to inject **Amgevita** are provided under 'Instructions for use'.

If you accidentally have taken a higher dosage

If you accidentally inject **Amgevita** more frequently than instructed by your doctor or pharmacist, call your doctor or the pharmacist and tell them about it. Always take the outer carton of the medicine with you, even if it is empty.

If you forgot to inject Amgevita

If you forgot to inject **Amgevita**, you should inject the next dose as soon as you remember. Then take your next dose as you would have on your originally scheduled day, had you not forgotten a dose.

Adhere to the treatment as recommended by the doctor.

Even if there is an improvement in your health, do not stop the medicine treatment without consulting the doctor.

If you stop using Amgevita

The decision to stop using **Amgevita** should be discussed with your doctor. Your symptoms may return if you stop using **Amgevita**.

Do not take medicines in the dark! Check the label and the dose each time you take a medicine. Wear glasses if you need them.

If you have any further questions regarding the use of this medicine, consult the doctor or pharmacist.

4. Possible side effects

As with any medicine, using **Amgevita** may cause side effects in some of the users. Do not be alarmed when reading the list of side effects. You may not suffer from any of them.

Most side effects are mild to moderate. However, some of the side effects may be serious and require treatment. Side effects may occur at least up to 4 months after the last **Amgevita** treatment.

Refer to your doctor immediately if you notice one of the following symptoms:

- severe rash, hives or other signs of allergic reaction
- swollen face, hands, feet
- difficulty breathing, difficulty swallowing
- shortness of breath with physical activity or upon lying down or swelling of the feet

Refer to your doctor as soon as possible if you notice one of the following symptoms:

- signs of infection, such as: fever, feeling sick, wounds, dental problems, burning upon urination
- feeling weak or tired
- cough
- tingling
- numbness
- double vision
- arm or leg weakness
- a bump or an open sore that does not heal
- signs and symptoms indicating blood disorders, such as: persistent fever, bruising, bleeding and paleness

The symptoms described above can be signs of the side effects listed below, which have been observed during treatment with **Amgevita**.

Very common side effects (effects that occur in more than 1 in 10 users):

- injection site reactions (including pain, swelling, redness or itching);
- respiratory tract infections (including cold, runny nose, sinus infection, pneumonia);
- headache;
- abdominal pain;
- nausea and vomiting;
- rash;
- musculoskeletal pain.

Common side effects (effects that occur in 1-10 out of 100 users):

- serious infections (including blood poisoning and influenza);
- intestinal infections (including gastroenteritis);
- skin infections (including cellulitis and shingles);
- ear infections;
- oral infections (including tooth infections and cold sores);
- reproductive tract infections;
- urinary tract infection;
- fungal infections;
- joint infections;
- benign tumours;
- skin cancer;
- allergic reactions (including seasonal allergy);
- dehydration;
- mood swings (including depression);
- anxiety;
- difficulty sleeping;
- sensation disorders such as tingling, prickling or numbness;
- migraine;
- nerve root compression (including low back pain and leg pain);
- vision disturbances;
- eye inflammation;
- inflammation of the eye lid and eye swelling;
- vertigo (feeling of dizziness);
- sensation of rapid heartbeat;
- high blood pressure;
- flushing;
- hematoma (collection of blood outside of blood vessels);
- cough;
- asthma;
- shortness of breath;
- gastrointestinal bleeding;
- dyspepsia (indigestion, bloating, heartburn);
- acid reflux disease;
- sicca syndrome (including dry eyes and dry mouth);
- itching;
- itchy rash;
- bruising;
- inflammation of the skin (such as eczema);
- breaking of finger nails and toe nails;
- increased sweating;
- hair loss;
- new onset or worsening of psoriasis;

- muscle spasms;
- blood in urine;
- kidney problems;
- chest pain;
- edema (swelling);
- fever;
- reduction in blood platelets which increases risk of bleeding or bruising;
- impaired healing.

Uncommon side effects (effects that occur in 1-10 out of 1,000 users):

- opportunistic infections (which include tuberculosis and other infections that occur when resistance to disease is lowered);
- neurological infections (including viral meningitis);
- eye infections;
- bacterial infections;
- diverticulitis (inflammation and infection of the large intestine);
- cancer;
- cancer that affects the lymph system (lymphoma);
- melanoma;
- immune disorders that could affect the lungs, skin and lymph nodes (most commonly presenting as sarcoidosis);
- inflammation of blood vessels (vasculitis);
- tremor (shaking);
- neuropathy (disorder of the nerves);
- stroke;
- hearing loss, buzzing;
- sensation of heart beating irregularly such as skipped beats;
- heart problems that can cause shortness of breath or ankle swelling;
- heart attack;
- a sac in the wall of a major artery, inflammation and clot of a vein, blockage of a blood vessel;
- lung diseases causing shortness of breath (including inflammation);
- pulmonary embolism (blockage in an artery of the lung);
- pleural effusion (abnormal collection of fluid in the pleural space);
- inflammation of the pancreas which causes severe pain in the abdomen and back;
- difficulty swallowing;
- facial edema (swelling of the face);
- gallbladder inflammation, gallbladder stones;
- fatty liver;
- night sweats;
- scarring;
- abnormal muscle breakdown;
- systemic lupus erythematosus (including inflammation of skin, heart, lung, joints and other organ systems);
- sleep interruptions;
- impotence;
- inflammations.

Rare side effects (effects that occur in 1-10 out of 10,000 users):

- leukemia (cancer affecting the blood and bone marrow);
- severe allergic reaction with shock;
- multiple sclerosis;
- nerve disorders (such as eye nerve inflammation and Guillain-Barré syndrome that may cause muscle weakness, abnormal sensations, tingling in the arms and upper body);
- heart stops pumping;
- pulmonary fibrosis (scarring of the lung);

- intestinal perforation (hole in the intestine);
- hepatitis;
- reactivation of hepatitis B virus;
- autoimmune hepatitis (inflammation of the liver caused by the body's own immune system);
- inflammation of blood vessels in the skin (cutaneous vasculitis);
- Stevens-Johnson syndrome (early symptoms include malaise, fever, headache and rash);
- facial edema (swelling of the face) associated with allergic reactions;
- erythema multiforme (inflammatory skin rash);
- lupus-like syndrome;
- angioedema (localised swelling of the skin);
- lichenoid skin reaction (itchy reddish-purple skin rash).

Side effects of unknown frequency (frequency cannot be estimated from the available data):

- hepatosplenic T-cell lymphoma (a rare blood cancer that is often causes death);
- Merkel cell carcinoma (a type of skin cancer);
- Kaposi's sarcoma, a rare cancer related to infection with human herpes virus 8. Kaposi's sarcoma mostly appears as purple lesions on the skin;
- liver failure;
- worsening of a condition called dermatomyositis (seen as a skin rash accompanying muscle weakness);
- Weight increased (in most patients the weight increase was minor).

Some side effects observed with the use of the medicine may not have symptoms and may only be discovered through blood tests. These include:

Very common side effects (effects that occur in more than 1 in 10 users):

- low levels of white blood cells;
- low levels of red blood cells;
- increased lipids in the blood;
- elevated liver enzymes.

Common side effects (effects that occur in 1-10 out of 100 users):

- high levels of white blood cells;
- low levels of platelets;
- increased uric acid in the blood;
- abnormal levels of sodium in the blood;
- low levels of calcium in the blood;
- low levels of phosphate in the blood;
- high blood sugar;
- high levels of the enzyme lactate dehydrogenase in the blood;
- autoantibodies present in the blood;
- low blood potassium.

Uncommon side effects (effects that occur in 1-10 out of 1,000 users):

- elevated bilirubin measurement (liver blood test).

Rare side effects (effects that occur in 1-10 out of 10,000 users):

- low levels of white blood cells, red blood cells and platelets.

If a side effect has appeared, if any of the side effects get worse or when you suffer from a side effect that has not been mentioned in the leaflet, you should consult the doctor.

Reporting of side effects

Side effects can be reported to the Ministry of Health by clicking on the link “reporting of side effects due to medical treatment” located on the Ministry of Health homepage (www.health.gov.il) which directs you to the online form for reporting side effects, or by entering the link: <https://sideeffects.health.gov.il>

5. How to store the medicine

Avoid poisoning! This medicine and any other medicine should be kept in a closed place out of the sight and reach of children and/or infants to avoid poisoning. Do not induce vomiting without an explicit instruction from the doctor.

Do not use the medicine after the expiry date (exp. date) appearing on the package. The expiry date refers to the last day of that month.

Store in a refrigerator (2°C – 8°C). Do not freeze.

Store in the original carton in order to protect from light.

Amgevita pre-filled pen or pre-filled syringe may be stored at temperatures up to a maximum of 25°C for a period of up to 14 days. The pre-filled pen or pre-filled syringe must be protected from light and discarded if not used within the 14-day period.

Do not throw away any medicines via wastewater or household waste. Ask your pharmacist how to throw away medicines you no longer use. These measures will help protect the environment.

6. Additional information

In addition to the active ingredient the medicine also contains: glacial acetic acid, sucrose, polysorbate 80, sodium hydroxide and water for injection.

What does the medicine look like and what is the content of the package?

Amgevita is a clear and colourless to slightly yellow solution.

Each pack contains 1, 2 or 6 single use SureClick pre-filled pens or pre-filled syringes.

Not all pack types may be marketed.

Manufacturer: Amgen Europe B.V., Minervum 7061, Breda, The Netherlands.

License Holder: Amgen Europe B.V., P.O. BOX 53313, Tel - Aviv.

Revised in December 2022 according to MoHs guidelines.

Registration number of the medicine in the National Drug Registry of the Ministry of Health:
165-56-36181

Instructions for use:
AMGEVITA single use SureClick pre-filled pen
For subcutaneous use

Guide to parts

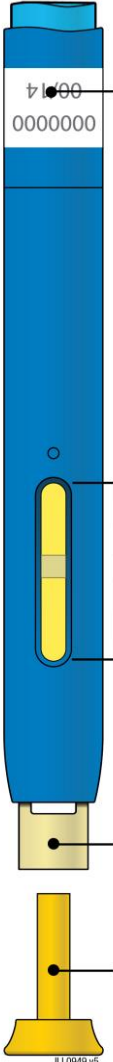
Before use	After use
<p data-bbox="389 412 608 443">Blue start button</p> <p data-bbox="237 555 438 586">Expiration date</p>  <p data-bbox="331 1010 438 1041">Window</p> <p data-bbox="320 1144 438 1176">Medicine</p> <p data-bbox="252 1256 438 1288">Yellow cap on</p> <p data-bbox="560 1279 600 1290">LL0949 v5</p>	<p data-bbox="1118 533 1319 564">Expiration date</p>  <p data-bbox="1118 994 1374 1061">Yellow window (injection complete)</p> <p data-bbox="1118 1279 1374 1310">Yellow safety guard</p> <p data-bbox="1118 1413 1303 1444">Yellow cap off</p> <p data-bbox="975 1503 1015 1514">LL0949 v5</p>

Important: Needle is inside

Important

Before you use an **AMGEVITA** pre-filled pen, read this important information:

Using your **AMGEVITA** pre-filled pen

- It is important that you do not try to give the injection unless you or your caregiver has received training.
- **Do not** use an **AMGEVITA** pre-filled pen if it has been dropped on a hard surface. Part of the **AMGEVITA** pre-filled pen may be broken even if you cannot see the break. Use a new **AMGEVITA** pre-filled pen.

Step 1: Prepare

A. Remove one **AMGEVITA** pre-filled pen from the package.

Carefully lift the pre-filled pen straight up out of the box.

Put the original package with any unused pre-filled pens back in the refrigerator.

For a more comfortable injection, leave the pre-filled pen at room temperature for **15 to 30** minutes before injecting.

- **Do not** put the pre-filled pen back in the refrigerator once it has reached room temperature.
- **Do not** try to warm the pre-filled pen by using a heat source such as hot water or microwave.
- **Do not** shake the pre-filled pen.
- **Do not** remove the yellow cap from the pre-filled pen yet.

B. Inspect the **AMGEVITA** pre-filled pen.

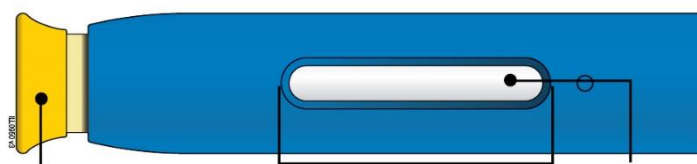

Yellow cap on

Window

Medicine

Make sure the medicine in the window is clear and colourless to slightly yellow.

- **Do not** use the pre-filled pen if:
 - The medicine is cloudy or discoloured or contains flakes or particles.
 - Any part appears cracked or broken.
 - The pre-filled pen has been dropped on a hard surface.
 - The yellow cap is missing or not securely attached.
 - The expiration date printed on the label has passed.

In all cases, use a new pre-filled pen.

C. Gather all materials needed for your injection.

Wash your hands thoroughly with soap and water.

On a clean, well-lit work surface, place a new, pre-filled pen.

You will also need these additional items, as they are not included in the carton:

- Alcohol wipes
- Cotton ball or gauze pad
- Plaster
- Sharps disposal container



D. Prepare and clean your injection site.

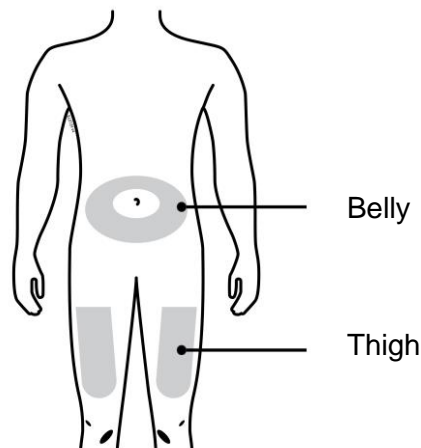

You can use:

- Your thigh
- Belly, except for a 5 centimetre area right around your belly button

Clean your injection site with an alcohol wipe. Let your skin dry.

- **Do not** touch this area again before injecting.
- If you want to use the same injection site, make sure it is not the same spot on the injection site you used for a previous injection.
 - **Do not** inject into areas where the skin is tender, bruised, red, or hard. Avoid injecting into areas with scars or stretch marks.
- If you have psoriasis, you should avoid injecting directly into raised, thick, red, or scaly skin patch or lesion.

Step 2: Get ready

E. Pull the yellow cap straight off when you are ready to inject.

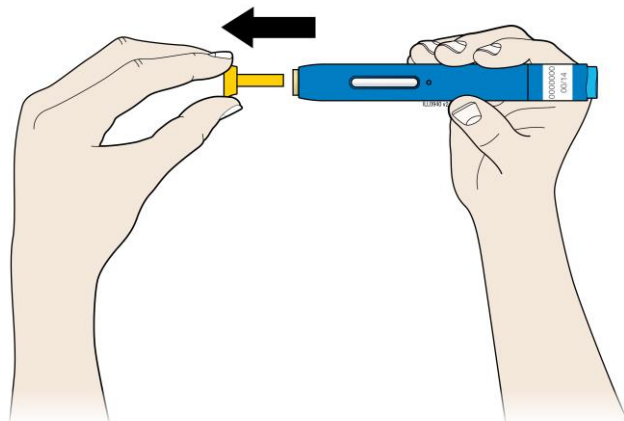

It is normal to see a drop of liquid at the end of the needle or yellow safety guard.

- **Do not** twist or bend the yellow cap.
- **Do not** put the yellow cap back onto the pre-filled pen.
- **Do not** remove the yellow cap from the pre-filled pen until you are ready to inject.

F. Stretch or pinch your injection site to create a firm surface.

Stretch method

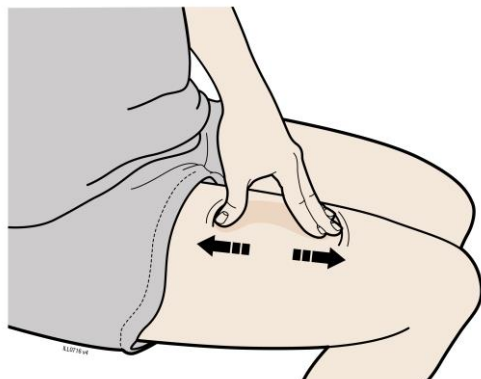

Stretch the skin firmly by moving your thumb and fingers in opposite directions, creating an area about **5** centimetre wide.

OR

Pinch method

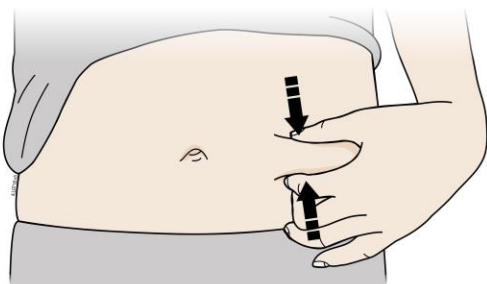

Pinch the skin firmly between your thumb and fingers, creating an area about **5** centimetre wide.

Important: Keep the skin stretched or pinched while injecting.

Step 3: Inject

- G.** Hold the stretch or pinch. With the yellow cap off, **place** the pre-filled pen on your skin at 90 degrees.

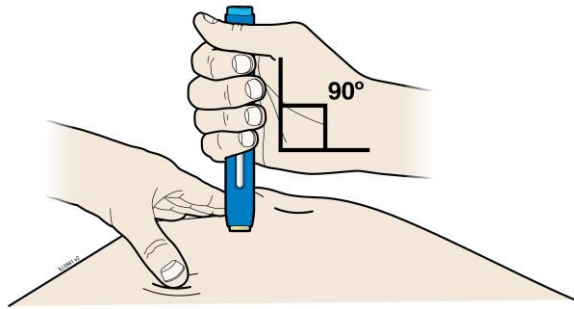

Important: Do not touch the blue start button yet.

- H.** Firmly **push** the pre-filled pen down onto the skin until it stops moving.

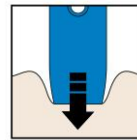
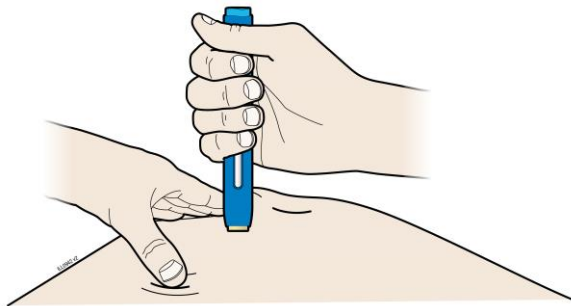

Push down

Important: You must push all the way down but do not touch the blue start button until you are ready to inject.

- I.** When you are ready to inject, **press** the blue start button. You will hear a click.

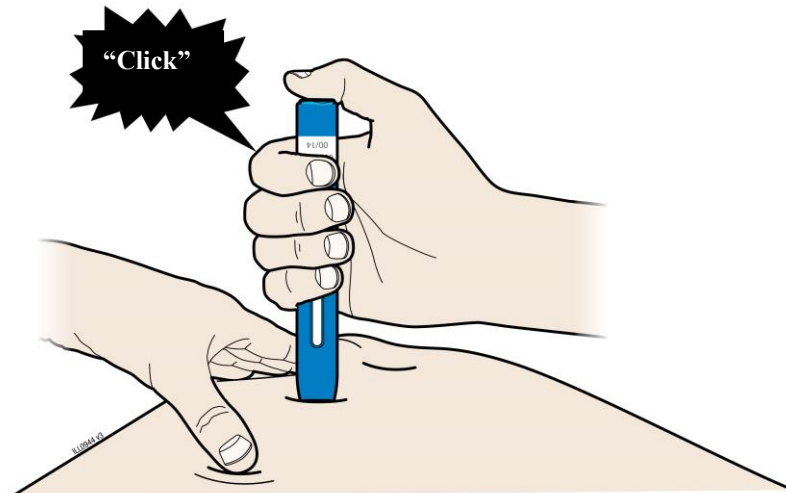

J. Keep **pushing** down on your skin. Your injection could take about 10 seconds.

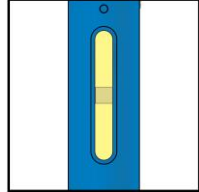
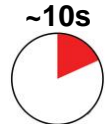
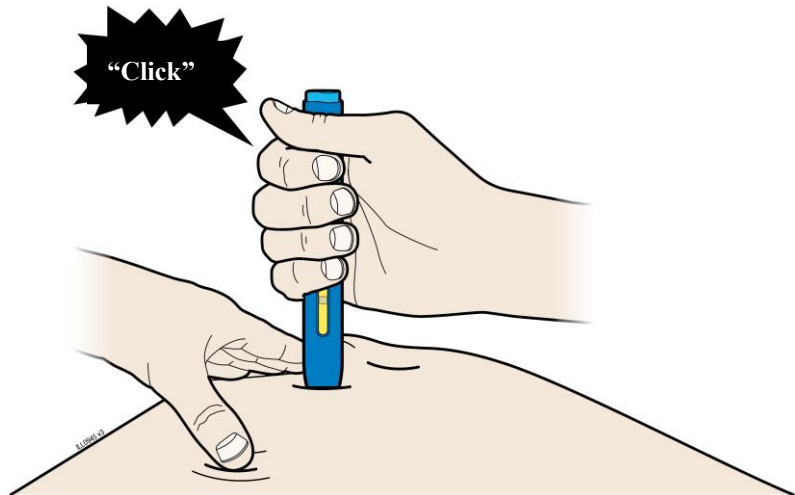

The window turns yellow when the injection is done. You may hear a second click.

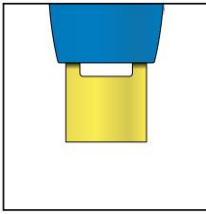

Note: After you remove the pre-filled pen from your skin, the needle will be automatically covered.

Important: When you remove the pre-filled pen, if the window has not turned yellow, or if it looks like the medicine is still injecting, this means you have not received a full dose. Call your doctor immediately.

Step 4: Finish

K. Discard the used pre-filled pen and the yellow cap.

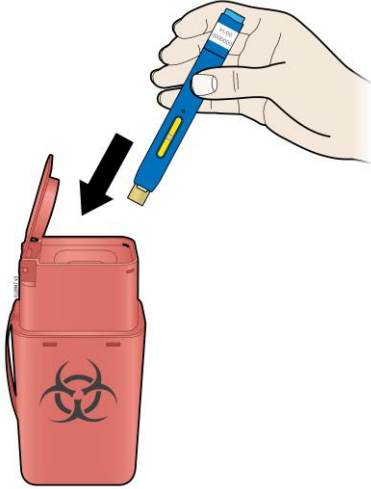

- Put the used pre-filled pen in a sharps disposal container immediately after use. **Do not** throw away (dispose of) the pre-filled pen in your household waste.
- Talk with your doctor or pharmacist about proper disposal. There may be local guidelines for disposal.
- **Do not** reuse the pre-filled pen.
- **Do not** recycle the pre-filled pen or sharps disposal container or throw them into the household waste.

Important: Always keep the sharps disposal container out of the sight and reach of children.

L. Examine the injection site.

If there is blood, press a cotton ball or gauze pad on your injection site. **Do not** rub the injection site. Apply a plaster if needed.

Instructions for use:
 AMGEVITA single use pre-filled syringe
 For subcutaneous use

Guide to parts

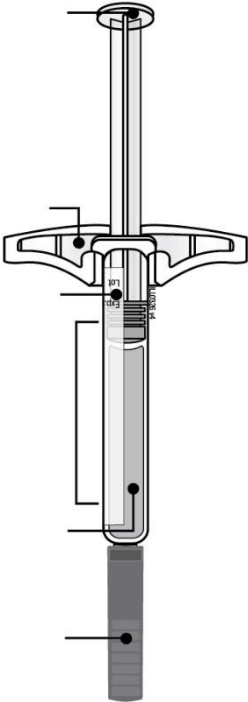
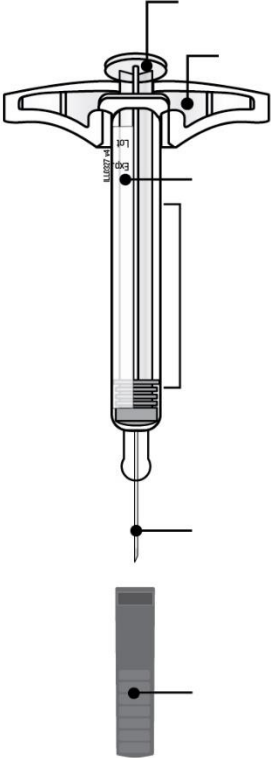
Before use	After use
<p>Plunger rod</p> <p>Finger flange</p> <p>Label and expiration date</p> <p>Syringe barrel</p> <p>Medicine</p> <p>Needle cap on</p> 	<p>Used plunger rod</p> <p>Finger flange</p> <p>Label and expiration date</p> <p>Used syringe barrel</p> <p>Used needle</p> <p>Needle cap off</p> 

Important: Needle is inside

Important

Before you use an AMGEVITA pre-filled syringe, read this important information:

Using your AMGEVITA pre-filled syringe

- It is important that you do not try to give the injection unless you or your caregiver has received training.
- **Do not** use an AMGEVITA pre-filled syringe if it has been dropped on a hard surface. Part of the AMGEVITA pre-filled syringe may be broken even if you cannot see the break. Use a new AMGEVITA pre-filled syringe.

Step 1: Prepare

- A. Remove the number of AMGEVITA pre-filled syringes you need from the package.

Grab the syringe barrel to remove the syringe from the tray.

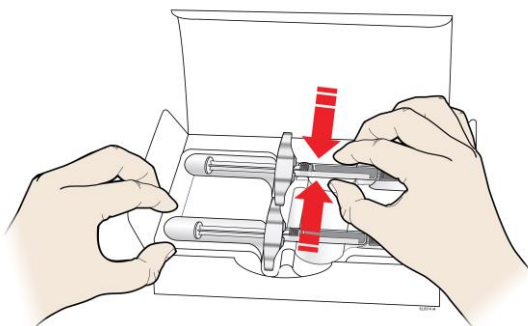
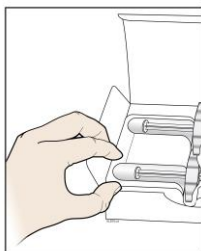

Grab Here

Place your finger or thumb on edge of tray to secure it while you remove the syringe.

Put the original package with any unused syringes back in the refrigerator.

For safety reasons:

- **Do not** grasp the plunger rod.
- **Do not** grasp the needle cap.
- **Do not** remove the needle cap until you are ready to inject.
- **Do not** remove the finger flange. This is part of the syringe.

For a more comfortable injection, leave the syringe at room temperature for **15 to 30** minutes before injecting.

- **Do not** put the syringe back in the refrigerator once it has reached room temperature.
- **Do not** try to warm the syringe by using a heat source such as hot water or microwave.
- **Do not** leave the syringe in direct sunlight.
- **Do not** shake the syringe.

Important: Always hold the pre-filled syringe by the syringe barrel.

B. Inspect the **AMGEVITA** pre-filled syringe.

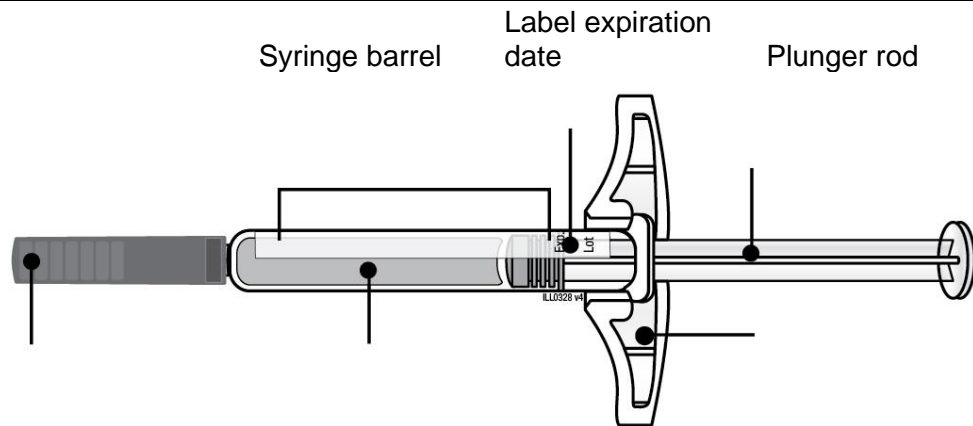

Needle cap on Medicine Finger flange

Always hold the syringe by the syringe barrel.

Make sure the medicine in the syringe is clear and colourless to slightly yellow.

- **Do not** use the syringe if:
 - The medicine is cloudy or discoloured or contains flakes, or particles.
 - Any part appears cracked or broken.
 - The needle cap is missing or not securely attached.
 - The expiration date printed on the label has passed.

In all cases, use a new syringe.

C. Gather all materials needed for your injection(s).

Wash your hands thoroughly with soap and water.
On a clean, well-lit work surface, place a new, pre-filled syringe.

You will also need these additional items, as they are not included in the carton:

- Alcohol wipes
- Cotton ball or gauze pad
- Plaster
- Sharps disposal container

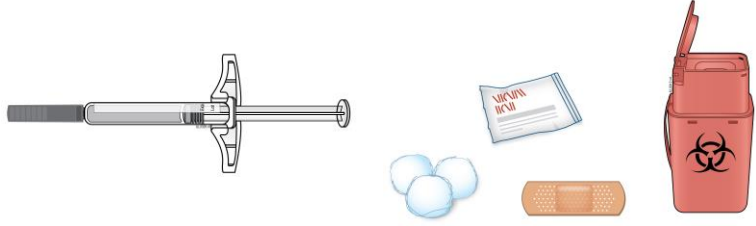

D. Prepare and clean your injection site(s).

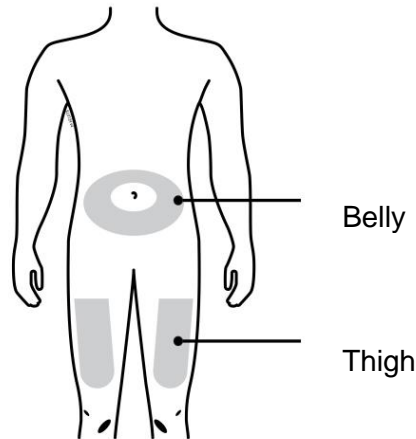

You can use:

- Your thigh
- Belly, except for 5 centimetres area around your belly button

Clean your injection site with an alcohol wipe. Let your skin dry.

- **Do not** touch this area again before injecting.
- If you want to use the same injection site, make sure it is not the same spot on the injection site you used for a previous injection.
 - **Do not** inject into areas where the skin is tender, bruised, red, or hard. Avoid injecting into areas with scars or stretch marks.
- If you have psoriasis, you should avoid injecting directly into raised, thick, red, or scaly skin patch or lesion.

Step 2: Get ready

E. Pull the needle cap straight out and away from your body when you are ready to inject.

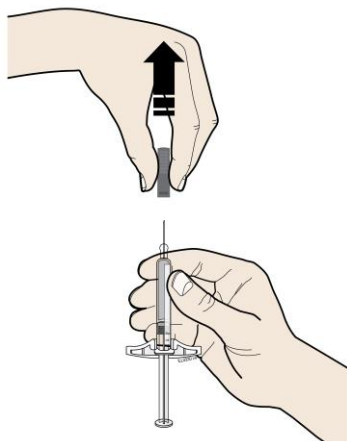

It is normal to see a drop of liquid at the end of the needle.

- **Do not** twist or bend the needle cap.
- **Do not** put the needle cap back onto the syringe.
- **Do not** remove the needle cap from the syringe until you are ready to inject.

Important: Throw the needle cap into the sharps disposal container provided.

F. Pinch your injection site to create a firm surface.

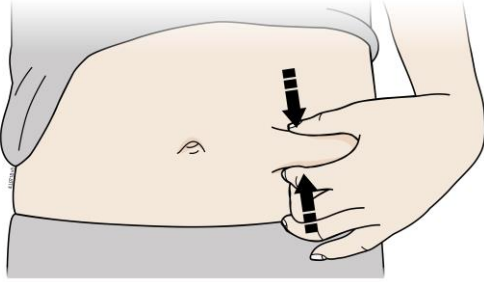

Pinch the skin firmly between your thumb and fingers, creating an area about 5 centimetres wide.

Important: Keep the skin pinched while injecting.

Step 3: Inject

G. Hold the pinch. With the needle cap off, insert the syringe into your skin at 45 to 90 degrees.

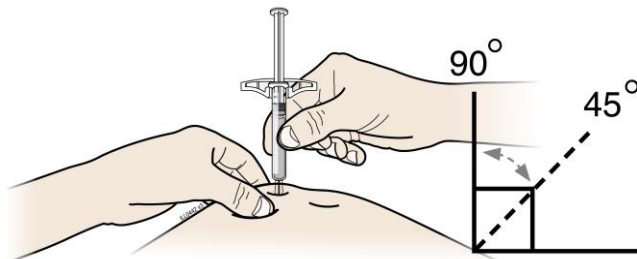

Do not place your finger on the plunger rod while inserting the needle.

H. Using slow and constant pressure, push the plunger rod all the way down until it stops moving.

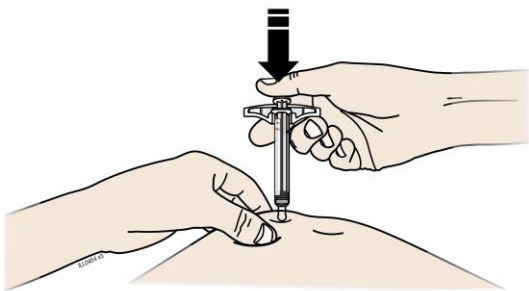

I. When done, release your thumb, and gently lift the syringe off of your skin.

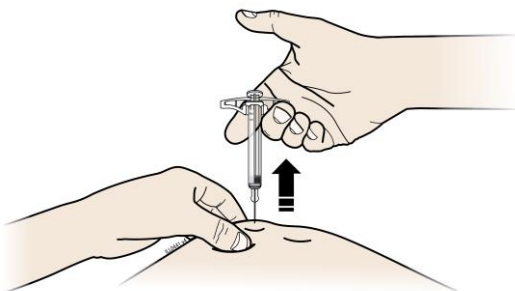

Step 4: Finish

J. Discard the used syringe and the needle cap.



- **Do not** reuse the used syringe.
- **Do not** use any medicine that is left in the used syringe.
- Put the used **AMGEVITA** syringe in a sharps disposal container immediately after use. **Do not** throw away (dispose of) the syringe in your household waste.
- Talk with your doctor or pharmacist about proper disposal. There may be local guidelines for disposal.
- **Do not** recycle the syringe or sharps disposal container or throw them into the household waste.

Important: Always keep the sharps disposal container out of the sight and reach of children.

K. Examine the injection site.

If there is blood, press a cotton ball or gauze pad on your injection site. **Do not** rub the injection site. Apply a plaster if needed.